

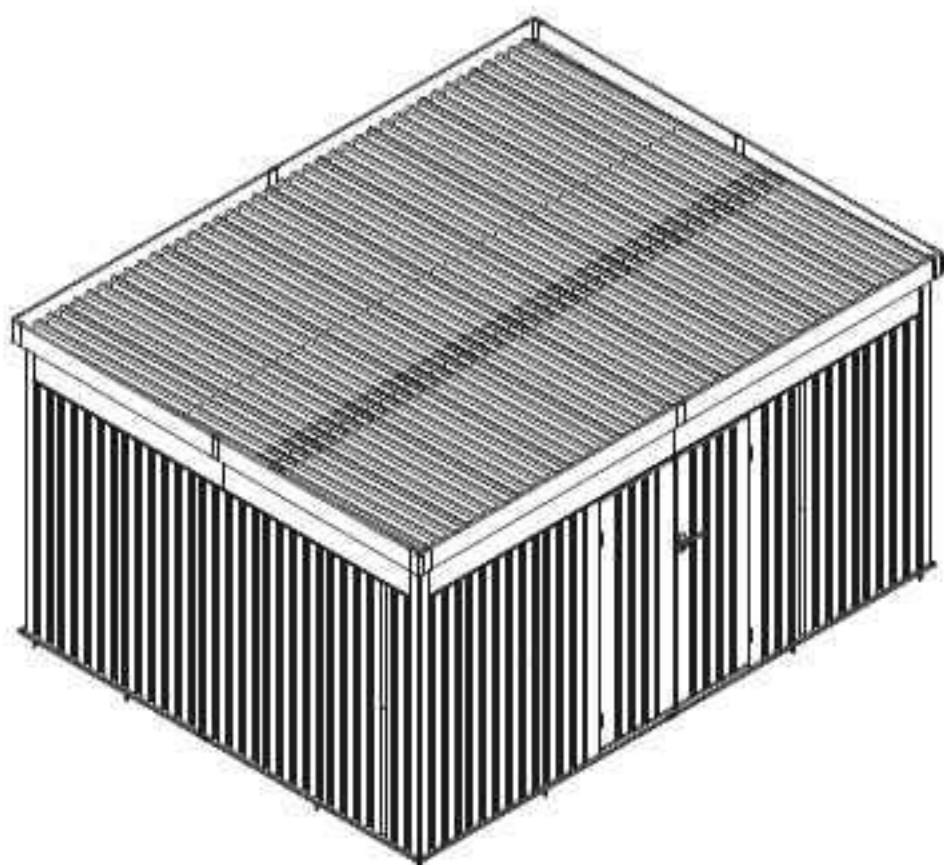

Supply24

since 2004



Tool shed Lyon XL - 12 m²

- DE **Gebrauchs- und Montageanleitung**
- EN **Operating and assembly instructions**
- FR **Instructions d'utilisation et de montage**
- IT **Istruzioni per l'uso e il montaggio**
- ES **Instrucciones de montaje y de uso**



Inhalt

1. Zu Ihrer Sicherheit	4
1.1 Zu Ihrer Sicherheit.....	4
1.2 Bestimmungsgemäß gebrauchen.....	4
1.3 Nicht bestimmungsgemäß gebrauchen.....	4
1.4 Zielgruppe.....	4
1.5 Warnstufen.....	4
1.6 Symbole.....	5
1.7 Sicherheitshinweise.....	5
2. Beschreibung und Funktion	5
3. Auspacken und prüfen	5
3.1 Produkt auspacken.....	5
4. Standort auswählen	6
4.1 Gerätehaus auf einem Holzfundament installieren.....	6
4.2 Gerätehaus auf Betonplatten installieren.....	6
5. Montieren	6
6. Transportieren	7
7. Gebrauchen	7
8. Demontieren	7
9. Lagern	7
10. Reinigen und Warten	7
10.1 Reinigen.....	7
10.2 Wartungsplan.....	7
11. Reparieren	7
12. Technische Daten	8
13. Entsorgen	8
13.1 Verpackung.....	8
13.2 Produkt allgemein.....	8
14. Teileliste	33
15. Montieren	38

1. Zu Ihrer Sicherheit

1.1 Zu Ihrer Sicherheit

- ▶ Lesen Sie dieses Dokument aufmerksam und vollständig.
- ▶ Befolgen Sie die Anweisungen und Sicherheitshinweise in diesem Dokument und am Produkt.
- ▶ Verwenden Sie das Produkt nur in technisch einwandfreiem Zustand sowie sicherheitsbewusst und gefahrenbewusst.
- ▶ Heben Sie dieses Dokument zum Nachschlagen und für die Weitergabe auf und nahe des Produktes verfügbar.

1.2 Bestimmungsgemäß gebrauchen

Das Produkt ist ausschließlich für den Privatgebrauch entwickelt worden.

- ▶ Nutzen Sie das Produkt ausschließlich als Gerätehaus im Außenbereich.
- ▶ Verwenden Sie das Produkt nur vollständig montiert und auf einem Fundament gesichert.
- ▶ Verwenden Sie das Produkt nur im Originalzustand, mit den gelieferten Originalteilen und/oder vom Hersteller freigegebenen Ersatzteilen.
- ▶ Lassen Sie Reparaturen nur von Fachpersonal durchführen.

Jede abweichende Nutzung gilt als nicht bestimmungsgemäße Verwendung und kann schwere Personen- und Sachschäden zur Folge haben.

Bei Nichtbeachtung der Hinweise und daraus resultierenden Schäden an Personen und Gegenständen übernehmen wir keine Haftung.

1.3 Nicht bestimmungsgemäß gebrauchen

Das Produkt ist nicht für gewerbliche Zwecke geeignet.

Das Produkt ist kein Spielzeug.

- ▶ Benutzen Sie das Produkt nicht mit defekten Teilen.
- ▶ Blockieren Sie keine Öffnungen und Zugänge.
- ▶ Blockieren Sie die Tür nicht, sie dient auch als Fluchtweg.
- ▶ Betreiben oder lagern Sie keine Wärmequellen wie Feuer oder Grills im Inneren des Produktes.
- ▶ Verwenden Sie das Produkt nicht in der Nähe von Wärmequellen, wie beispielsweise Grillgeräten, Heizstrahlern, Kerzen oder offenem Feuer.
- ▶ Vermeiden Sie das Montieren, Demontieren und Aufstellen des Produktes bei starken Windböen, starkem Regen, Gewitter oder Hagel.
- ▶ Hängen Sie keine schweren Gegenstände an das Produkt.
- ▶ Stellen Sie keine Gegenstände auf das Produkt.

- ▶ Stellen Sie sich nicht auf das Produkt.
- ▶ Entfernen Sie sofort Schneemassen vom Dach. Es besteht Einsturzgefahr.

1.4 Zielgruppe

Benutzer sind Erwachsene und Kinder ab 12 Jahren unter Beaufsichtigung eines Erwachsenen, die die Gebrauchsanleitung und Kennzeichnungen auf dem Produkt gelesen und verstanden oder eine vergleichbare Einweisung hinsichtlich Gebrauch und Sicherheitshinweisen bekommen haben.

Personen mit körperlich oder geistig eingeschränkten Fähigkeiten dürfen das Produkt nur unter Aufsicht eines erwachsenen Benutzers benutzen.

Montagearbeiten, Wartungsarbeiten und Reinigung dürfen nicht von Kindern ausgeführt werden. Benutzer dürfen das Produkt nur in Vollbesitz ihrer physischen, psychischen und sensorischen Fähigkeiten, also im wachen und nüchternen Zustand verwenden.

Fachpersonal sind mit mechanischer Fachausbildung geschulte Personen wie ausgebildete Handwerker, Metallbauer, etc.

1.5 Warnstufen

GEFÄHR

Warnung vor Gefahren, die bei Missachtung der Maßnahmen **unmittelbar zu Tod** oder schweren Verletzungen führen.

WARNUNG

Warnung vor Gefahren, die bei Missachtung der Maßnahmen zu **Tod oder schweren** Verletzungen führen können.

VORSICHT

Warnung vor Gefahren, die bei Missachtung der Maßnahmen zu **Verletzungen** führen können.

ACHTUNG

Warnung vor Gefahren, die bei Missachtung der Maßnahmen zu **Sachschäden** führen können.

1.6 Symbole

Symbol Bezeichnung



Dieses Symbol weist darauf hin, dass der Benutzer die Anleitung vor Gebrauch gelesen und verstanden haben soll.



Dieses Symbol weist darauf hin, dass der Benutzer bei Arbeiten an dem Produkt Schutzhandschuhe tragen soll.



Dieses Symbol weist darauf hin, dass Arbeiten an dem Produkt mit mindestens einer weiteren Person erfolgen sollen.

- ▶ Nicht reihenfolgenbezogene Handlungsanweisungen.
-  Das internationale Recycling-Symbol weist auf wiederverwertbares Material hin.
-  Dieses Symbol weist darauf hin, dass die Benutzung von elektrischen Schraubern verboten ist.
-  Das ECOEMBES-Logo ist ein gesetzlich vorgeschriebenes Recycling-Symbol, das in Spanien eingeführt wurde und auf recycelbare Produkte und Verpackungen hinweist, die getrennt gesammelt werden müssen.
-  Das Triman-Logo ist ein gesetzlich vorgeschriebenes Recycling-Symbol, das in Frankreich eingeführt wurde und auf recycelbare Produkte und Verpackungen hinweist, die getrennt gesammelt werden müssen.

1.7 Sicherheitshinweise

- ⚠️ WARNUNG**

Brandgefahr durch Wärmequellen.

Das Produkt besteht aus brennbaren Materialien.

 ▶ Halten Sie das Produkt fern von Wärmequellen, wie beispielsweise Grillgeräten, Heizstrahlern, Kerzen oder offenem Feuer.
- ⚠️ VORSICHT**

Hitzschlag!

 ▶ Halten Sie sich bei hohen Temperaturen und hoher Luftfeuchte nur kurzzeitig im Inneren des Produktes auf und verlassen Sie es sofort bei Unwohlsein.
- ⚠️ VORSICHT**

Verletzungen und Sachschaden.

Modifizierung des Produktes kann zu Verletzungen und Sachschäden sowie zum Erlöschen der Gewährleistung führen.

 ▶ Verwenden Sie das Produkt nur mit den gelieferten Originalteilen und im Originalzustand.

▶ Verwenden Sie nur vom Hersteller freigegebene Ersatzteile.

- ⚠️ VORSICHT**

Verletzungsgefahr durch Schneiden.

 ▶ Fassen Sie Teile wie gebrochene oder gratenthaltende Materialien nicht mit bloßen Händen an.

▶ Nutzen Sie geeignete Schutzausrüstung und Werkzeuge.

2. Beschreibung und Funktion

Dieses Produkt ist ein Gerätehaus für den Garten. Es bietet eine große Lagerfläche für die Aufbewahrung von Gartengeräten. Durch die widerstandsfähige und stabile Konstruktion werden diese vor Witterungseinflüssen geschützt. Das Gerätehaus verfügt über extra hohe Wände um den Zugang zu vereinfachen und mehr Stauraum und Bewegungsfreiheit zu bieten. Des Weiteren verfügt das Gerätehaus über zwei große, abschließbare Türen und ein integriertes, schnelles Regenentwässerungssystem.

3. Auspacken und prüfen

3.1 Produkt auspacken

- ⚠️ WARNUNG**

Erstickungsgefahr durch Verpackungsmaterial und durch Verschlucken von Kleinteilen.

 ▶ Entsorgen Sie das Verpackungsmaterial sofort vorschriftsmäßig im Hausmüll.

▶ Bewahren Sie zum Wiederverpacken notwendige Verpackungen und Kleinteile feuchtigkeitsgeschützt sowie für Kinder unzugänglich auf.
- ⓘ ACHTUNG**

Sachschaden.

 Spitze, scharfe und kratzende Gegenstände können das Produkt beim Öffnen der Verpackung beschädigen.

▶ Benutzen Sie keine spitzen, scharfen oder kratzenden Gegenstände zum Öffnen der Verpackung.

1. Entnehmen Sie alle Teile aus dem Karton.
2. Legen Sie die Teile nebeneinander auf eine freie, weiche und ebene Fläche.
3. Prüfen Sie den Lieferumfang auf Vollständigkeit und Unversehrtheit, siehe Kapitel „14. Teilleiste“ auf Seite 33.

4. Standort auswählen

VORSICHT

Verletzungsgefahr und Sachschaden.

- ▶ Stellen Sie das Produkt ordnungsgemäß und standsicher auf.
- ▶ Verbinden Sie nicht 2 Gerätehäuser miteinander.

ACHTUNG

Sachschaden durch Schneelasten.

Schneelasten, die sich auf dem Dach des Produkts ansammeln oder auf das Produkt fallen, können das Produkt beschädigen.

- ▶ Achten Sie bei der Auswahl des Aufstellortes darauf, dass:

1. die Produktoberseite für die Schneeräumung gut zugänglich sind,
2. eine möglichst geringe Gefahr von Schneelasten besteht und
3. bei entsprechender Wetterlage Schneelasten regelmäßig und zeitnah vom Produkt geräumt werden.

- ▶ Informieren Sie sich vor dem Auswählen des Standorts und des Fundaments über eventuell zutreffende Bauvorschriften und -genehmigungen bei der in Ihrem Bundesland zutreffenden Behörde.
- ▶ Der Standort sollte die folgenden Eigenschaften aufweisen:
 - der Untergrund ist eben, trocken und fest.
 - Über dem Untergrund befinden sich keine Hindernisse wie beispielsweise Äste von Bäumen oder Stromleitungen.
 - Der Mindestabstand von 3 m zum nächsten Gerätehaus sowie zu anderen Bauten und Grundstücksgrenzen wird eingehalten.

Hinweis: Montagematerial für die Befestigung der Basis auf einem Holzfundament ist nicht im Lieferumfang enthalten.

4.1 Gerätehaus auf einem Holzfundament installieren

1. Befestigen Sie die Punktfundament-Halterungen gleichmäßig am Holzgestell, beispielsweise mehrere Pfostenträger.
2. Bohren Sie mehrere Löcher für die Punktfundamente.
3. Schütten Sie Kies in die Bohrlöcher und richten Sie das Holzgestell waagrecht aus.
4. Gießen Sie Beton in die Löcher und lassen Sie den Beton trocknen.
5. Verteilen Sie Sand oder Kies unter dem Fundament, damit sich keine Feuchtigkeit unter dem Fundament sammelt.

6. Montieren Sie die Bodenleisten.
7. Folgen Sie den abgebildeten Montageschritten unter Beachtung der Sicherheitshinweise, siehe Kapitel „15. Montieren“ auf Seite 38.

4.2 Gerätehaus auf Betonplatten installieren

Hinweis: Für die Befestigung des Gerätehauses auf den Betonplatten werden 12x Ø 6x80 mm Universaldübel benötigt. Diese sind nicht im Lieferumfang enthalten.

Hinweis: Sind die Abstände der Löcher nicht bekannt, sollten diese anhand der Bodenleisten ermittelt und übertragen werden.

1. Verlegen Sie mehrere Betonplatten am gewählten Aufstellort.
2. Schlämmen Sie die Betonplatten ein.
3. Bohren Sie mit einem Steinbohrer Ø6 mm die benötigten Bohrlöcher in die Betonplatten.
4. Säubern Sie die Bohrlöcher.
5. Drücken Sie die Dübel in die Bohrlöcher.
6. Montieren Sie die Bodenleisten mit den mitgelieferten Schrauben
7. Folgen Sie den abgebildeten Montageschritten unter Beachtung der Sicherheitshinweise, siehe Kapitel „15. Montieren“ auf Seite 38.

5. Montieren

VORSICHT

Sachschaden.

Die folgenden Montageschritte sollten bereits auf dem Fundament am vorher ausgewählten Standort durchgeführt werden, um Schnitte und Quetschungen zu vermeiden und das Produkt nicht durch den Transport zu beschädigen.

- ▶ Verwenden Sie für die Befestigung der Basis auf Betonplatten geeignetes Montagematerial.

ACHTUNG

Beschädigung des Produktes durch fehlerhafte Montage.

- ▶ Bauen Sie das Produkt vollständig und sicher auf.
- ▶ Bauen Sie das Produkt mit mindestens einer zweiten Person auf.
- ▶ Schrauben Sie die Schrauben handfest in die Verbindungslöcher und ziehen Sie die Schrauben erst im letzten Schritt fest, um ein Verkannten der Teile zu verhindern.

6. Transportieren

VORSICHT

Verletzungsgefahr und Sachschäden durch falschen Transport.

- ▶ Transportieren Sie das Gerätehaus nur im demontierten Zustand.
- ▶ Kleinere Standortkorrekturen führen Sie nur unter Zuhilfenahme einer 2. Person und mit Schutzausrüstung aus.

7. Gebrauchen

VORSICHT

Verletzungsgefahr durch unsachgemäßen Gebrauch.

- ▶ Verwenden Sie das Produkt entsprechend der bestimmungsgemäßen Verwendung, siehe Kapitel „1.2 Bestimmungsgemäßgebrauchen“ auf Seite 4“.

ACHTUNG

Beschädigung des Produktes durch starke Witterung.

- ▶ Halten Sie Öffnungen, wie Türen oder Fenster bei Wind stets geschlossen.

8. Demontieren

- ▶ Demontieren Sie das Produkt in umgekehrter Montagereihenfolge, siehe Kapitel „15. Montieren“ auf Seite 38.

9. Lagern

ACHTUNG

Sachschäden durch fehlerhaftes Lagern.

- ▶ Lagern Sie das Produkt demontiert an einem trockenen, sauberen Ort.
- ▶ Schützen Sie das Produkt vor Staub und Feuchtigkeit.
- ▶ Stellen Sie keine Gegenstände wegen auftretender Verformungen auf das Produkt.

10. Reinigen und Warten

10.1 Reinigen

ACHTUNG

Beschädigung des Produktes durch falsche Reinigungsmittel.

- ▶ Prüfen Sie die Verträglichkeit der Reinigungsmittel mit der Oberfläche an einer unauffälligen Stelle am Produkt.
- ▶ Verwenden Sie zur Reinigung keine organischen Lösungsmittel, kochendes Wasser, starke Säuren oder alkalische Reiniger.

- ▶ Entfernen Sie Staub und leichten Schmutz mit einem angefeuchteten Tuch oder einer weichen Bürste.
- ▶ Benutzen Sie bei größeren Verschmutzungen einen milden, nicht entflammbar und lebensmittelverträglichen Reiniger oder ein mit Wasser angefeuchtetes Tuch.
- ▶ Entfernen Sie tierische Exkremente, Laub, Schnee und andere gröbere Verschmutzungen regelmäßig und umgehend vom Dach des Produktes.
- ▶ Schmieren Sie die Lauffläche und bewegliche Teile der Tür mit etwas Schmier spray.

10.2 Wartungsplan

Regelmäßige Wartung erhöht die Sicherheit und die Langlebigkeit Ihres Produktes.

Vor jeder Benutzung

Zustand

- ▶ Kontrollieren Sie den Gesamtzustand des Produktes auf Beschädigungen.

Anbauteile

- ▶ Kontrollieren Sie, ob sich Anbauteile gelöst oder verzogen haben und fixieren Sie diese wieder bei Bedarf.

11. Reparieren

ACHTUNG

Beschädigung durch unsachgemäße Reparatur.

- ▶ Verwenden Sie nur vom Hersteller freigegebene oder originale Ersatzteile.
- ▶ Lassen Sie Reparaturen nur von Fachpersonal durchführen.

12. Technische Daten

Bezeichnung	Wert
Material Gerätehaus:	Stahlblech (verzinkt)
Material Türgriff:	Kunststoff
Maße (Breite x Tiefe x Höhe)	
Außenmaße:	396x294x220 cm
Innenmaße:	389x287x190 cm
Tür:	110x180 cm
Gewicht:	1,65 kg

13. Entsorgen

13.1 Verpackung

Das Verpackungsmaterial ist wiederverwertbar.

- Entsorgen Sie die Verpackung umweltgerecht und führen Sie diese der regionalen Wertstoffsammlung zu.

13.2 Produkt allgemein

Dieses Produkt gehört nicht in den Hausmüll. Geben Sie es am Ende seiner Lebensdauer an den Hersteller, die Verkaufsstelle oder an dafür eingerichtete, öffentliche Sammelstellen kostenlos zurück. Einzelheiten zur Entsorgung regelt das jeweilige Landesrecht. Wertstoffe werden dem Recyclingkreislauf zugeführt, um daraus neue Rohstoffe zu gewinnen. Folgende Wertstoffe werden in kommunalen Sammelstellen gesammelt:

- Altglas, Kunststoffe, Altmetalle, Bleche uvm.

Mit dieser Art der Verwertung von Altprodukten leisten Sie einen wichtigen Beitrag zum Schutz unserer Umwelt.

Content

1. For your safety	10
1.1 For your safety.....	10
1.2 Use as intended.....	10
1.3 Improper use.....	10
1.4 Target group.....	10
1.5 Warning levels.....	10
1.6 Symbols.....	11
1.7 Safety instructions.....	11
2. Description and function	11
3. Unpack and check	11
3.1 Unpacking the product.....	11
4. Select location	12
4.1 Install the tool shed on the wooden foundation.....	12
4.2 Installing the tool shed on concrete slabs.....	12
5. Mounting	12
6. Transport	13
7. Use	13
8. Disassembly	13
9. Store	13
10. Maintenance and schedule	13
10.1 Cleaning.....	13
10.2 Maintenance plan.....	13
11. Repairing	13
12. Technical data	14
13. Disposing	14
13.1 Packaging.....	14
13.2 Product in general.....	14
14. Part list	33
15. Assembly	38

1. For your safety

1.1 For your safety

- ▶ Read this document carefully and completely.
- ▶ Follow the instructions and safety information in this document and on the product.
- ▶ Only use the product in perfect technical condition and in a safety-conscious and risk-aware manner.
- ▶ Keep this document for future reference and forwarding, as well as available near the product.

1.2 Use as intended

The product has been developed exclusively for private use.

- ▶ Only use the product as an outdoor shed.
- ▶ Only use the product fully assembled and secured on a solid base.
- ▶ Only use the product in its original condition, with the original parts supplied and/or spare parts approved by the producer.
- ▶ Only have repairs carried out by qualified personnel.

Any other use is considered improper use and can result in severe personal injury and damage to property.

We accept no liability for non-compliance with instructions, safety instructions and improper use or any resulting damage to persons or property.

1.3 Improper use

The product is not suitable for commercial purposes.

The product is not a toy.

- ▶ Do not use the product with defective parts.
- ▶ Do not block any openings and accesses.
- ▶ Do not block the door, it also serves as an escape way.
- ▶ Do not operate or store heat sources like fires or barbecues inside the product.
- ▶ Do not use the product near heat sources like grills, radiant heaters, candles or open fires.
- ▶ Avoid assembling, disassembling and setting up the product during strong wind blasts, heavy rain, thunderstorms or hail.
- ▶ Do not hang heavy objects on the product.
- ▶ Do not place heavy objects on the product.
- ▶ Do not stand on the product.
- ▶ Remove snow from the roof immediately. There is a risk of collapse.

1.4 Target group

Users are adults and children over 12 years under adult supervision, who have read and understood these instructions and the markings on the product or have received comparable instruction with regard to use and safety instructions.

Persons with physical or mental disabilities/children/pregnant women may only use the product under the supervision of an adult.

Assembly work, maintenance work and cleaning may not be carried out by the aforementioned persons.

Users may only use the product when they are in full physical, mental and sensoric abilities, i.e. when they are awake and sober.

Skilled personnel are people who have received specialist mechanical training, such as trained craftsmen, metalworkers etc.

1.5 Warning levels

DANGER

Warning of dangers that will lead **directly to death** or serious injuries if the measures are ignored.

WARNING

Warning of dangers that can result in **death** or **serious injury** if the measures are ignored.

CAUTION

Warning of dangers that can lead to **injuries** if the measures are ignored.

NOTICE

Warning of dangers that can lead to **material damage** if the measures are ignored.

1.6 Symbols

Symbol	Description
	This symbol indicates that the user should have read and understood the instructions before use.
	This symbol indicates that the user should wear protective gloves when working on the product.
	This symbol indicates that work on the product should be performed with at minimum one other person.
	Non-sequential instructions for action.
	The international recycling symbol indicates recyclable material.
	This symbol indicates that the use of electric screwdrivers is prohibited.
	The ECOEMBES logo is a legally required recycling symbol introduced in Spain that indicates recyclable products and packaging that must be collected separately.
	The Triman logo is a legally required recycling symbol introduced in France that indicates recyclable products and packaging that must be collected separately.

1.7 Safety instructions

	WARNING
	<p>Fire hazard from heat sources.</p> <p>The product consists of flammable materials.</p> <ul style="list-style-type: none"> ▶ Keep the product away from heat sources such as barbecues, radiant heaters, candles or open fires.
	<p>CAUTION</p> <p>Heat stroke!</p> <ul style="list-style-type: none"> ▶ Only stay inside the product for a short time in high temperatures and high humidity and leave it immediately if you feel unwell.

	<p>CAUTION</p> <p>Injuries and property damage.</p> <p>Modification of the product may result in personal injury and property damage and will void the warranty.</p> <ul style="list-style-type: none"> ▶ Only use the product with the original parts supplied and in the original condition. ▶ Only use spare parts approved by the manufacturer.
--	---

	<p>CAUTION</p> <p>Risk of injury from cutting.</p> <ul style="list-style-type: none"> ▶ Do not handle parts such as broken or burr-containing materials with bare hands. ▶ Use suitable protective equipment and tools.
---	---

2. Description and function

This product is a garden shed. It has a large storage area for storing garden tools. The resistant and stable construction protects these from weather influences. The shed has extra-high walls to make access easier and to provide more storage space and freedom of movement. It also has two large lockable doors and an integrated fast rain-water drainage system.

3. Unpack and check

3.1 Unpacking the product

	<p>WARNING</p> <p>Risk of suffocation from packaging material and from swallowing small parts.</p> <ul style="list-style-type: none"> ▶ Dispose of the packaging material in the household waste according to regulations. ▶ Store the packaging and small parts required for repackaging away from moisture and out of reach of children.
---	--

	<p>NOTICE</p> <p>Material damage.</p> <p>Pointed, sharp and scratching objects can damage the product when opening the packaging.</p> <ul style="list-style-type: none"> ▶ Do not use any pointed, sharp or scratching objects to open the packaging.
---	--

1. Remove all parts from the box.
2. Lay the pieces side by side on a clear, soft, and level surface.
3. Check the scope of delivery for completeness and intactness, see chapter „14. Part list“ on page 33.

4. Select location

CAUTION

Risk of injury and damage to property.

- ▶ Set up the product properly and in a stable position.
- ▶ Do not connect 2 garden sheds to each other.

NOTICE

Material damage due to snow loads.

Snow loads that accumulate on the roof of the product or fall onto the product can damage the product.

- ▶ When selecting the installation location, ensure that:

1. the top of the product is easily accessible for snow removal,
2. the risk of snow loads is as low as possible and
3. snow loads are regularly and promptly cleared from the product in appropriate weather conditions.

- ▶ Before selecting the location and foundation, check with the relevant authority in your country for any applicable building regulations and permits.

- ▶ The site should have the following characteristics:

- the ground is level, dry and solid,
- There are no obstacles above the ground, such as tree branches or power lines.
- The minimum distance of 3 m to the next equipment house as well as to other structures and property boundaries is observed.

Note: Mounting material for attaching the base to a wooden foundation is not included in the scope of delivery.

4.1 Install the tool shed on the wooden foundation

1. Attach the point fundamentals evenly to the wooden frame, for example several post supports.
2. Drill several holes for the point fundamentals.
3. Fill the holes with grit and align the wooden frame horizontally.
4. Fill the holes with cement and allow the cement to dry.
5. Place sand or grit under the base to prevent it from moisture.

6. Fit the floor mouldings.
7. Follow the assembly steps shown, observing the safety instructions, see „15. Assembly“ on page 38.

4.2 Installing the tool shed on concrete slabs

Note: 12x Ø 6x80 mm universal dowels are required to attach the shed to the concrete slabs. These are not included in the scope of delivery

Note: If the distances between the holes are not known, these should be determined and transferred using the floor mouldings

1. Lay several concrete slabs at the chosen installation site
2. Slurry the concrete slabs
3. Drill the required holes in the concrete slabs using a Ø6 mm masonry drill bit
4. Clean the drill holes
5. Press the dowels into the drill holes
6. Fit the skirting boards using the screws supplied
7. Follow the assembly steps shown, observing the safety instructions, see „15. Assembly“ on page 38.

5. Mounting

CAUTION

Material damage.

The following assembly steps should already be carried out on the fundament at the previously selected location in order to avoid cuts and bruises and to avoid damaging the product during transport.

- ▶ Use suitable mounting material for fastening the base to cement plates.

NOTICE

Damage to the product due to incorrect assembly.

- ▶ Assemble the product completely and safely.
- ▶ Assemble the product with at least one second person.
- ▶ Screw the screws hand-tight into the connecting holes and only tighten the screws in the last step to prevent the parts from jamming.

6. Transport

CAUTION

Risk of injury and material damage due to incorrect transport

- ▶ Only transport the product when it is dismantled.
- ▶ Only carry out minor site corrections with the assistance of a second person and with protective equipment.

7. Use

CAUTION

Risk of injury due to improper use.

- ▶ Use the product in accordance with its intended use, see chapter „1.2 Use as intended“ on page 10.

NOTICE

Damage to the product due to strong weather.

- ▶ Always keep openings such as doors or windows closed in windy conditions.

8. Disassembly

- ▶ Disassemble the product in reverse order of assembly, see chapter „15. Assembly“ on page 38.

9. Store

NOTICE

Damage to the product due to incorrect storage.

- ▶ Store the product disassembled afterwards in a dark, cool, dry and well-ventilated place.
- ▶ Protect the product from dust and moisture.
- ▶ Do not place any objects on the product because of deformations that may occur.

10. Maintenance and schedule

10.1 Cleaning

NOTICE

Damage caused by incorrect cleaning agents.

- ▶ Check the compatibility of the cleaning agent with the surface on an inconspicuous area.
- ▶ Do not use any organic solvents, boiling water, strong acids or alkaline cleaning agents for cleaning.

- ▶ Remove dust and light dirt with a damp cloth or a soft brush.
- ▶ Use a mild, non-flammable and food-safe cleaning agent or a cloth dampened with water for heavy soiling. Regular maintenance increases the safety and longevity of your product.
- ▶ Remove animal excrement, leaves, snow and other coarser dirt from the roof of the product regularly and immediately.
- ▶ Lubricate running surfaces and moving parts with a little lubricating spray.

10.2 Maintenance plan

Regular maintenance increases the safety and longevity of your product.

Before each use

Condition

- ▶ Check the overall condition of the product.

Attachment parts

- ▶ Check whether attachment parts have become loose or distorted.

11. Repairing

NOTICE

Damage due to improper repair.

- ▶ Only use spare parts approved by the manufacturer or original ones.
- ▶ Only have repairs carried out by qualified personnel.

12. Technical data

Description	Value
Material garden shed:	galvanised steel
Material door handle:	plastic
Dimensions (Width x depth x height)	
Exterior dimensions:	396x294x220 cm
Interior dimensions:	389x287x190 cm
Door:	110x180 cm
Weight:	165 kg

13. Disposing

13.1 Packaging

The packaging material is recyclable.

► Dispose of the packaging in an environmentally friendly manner and take it to the regional collection of recyclables.

13.2 Product in general

This product does not belong in household waste. At the end of its service life, return it free of charge to the producer, point of sale or public collection points set up for this purpose. Details of disposal are regulated by the respective national law. Valuable materials are fed into the recycling cycle in order to gain new raw materials from them. The following recyclables are collected in municipal collection points:

- Waste: glass, plastics, scrap metal, sheet metal and much more.

With this type of recycling of old products you make an important contribution to the protection of our environment.

Table des matières

1. Pour votre sécurité	16
1.1 Pour votre sécurité.....	16
1.2 Utilisation conforme.....	16
1.3 Utilisation non conforme.....	16
1.4 Groupe cible.....	16
1.5 Niveaux d'avertissement.....	16
1.6 Symboles.....	17
1.7 Instructions de sécurité.....	17
2. Description et fonctionnement	17
3. Déballage et contrôle	17
3.1 Déballer le produit.....	17
4. Choisir l'emplacement	18
4.1 Installer la cabane à outils sur une fondation en bois.....	18
4.2 Installer la cabane à outils sur des dalles en béton.....	18
5. Montage	18
6. Transport	19
7. Utiliser	19
8. Démontage	19
9. Stockage	19
10. Nettoyage et maintenance	19
10.1 Nettoyage.....	19
10.2 Plan de maintenance.....	19
11. Réparation	19
12. Données techniques	20
13. Élimination	20
13.1 Emballage.....	20
13.2 Généralités relatives au produit.....	20
14. Liste des pièces	33
15. Montage	38

1. Pour votre sécurité

1.1 Pour votre sécurité

- ▶ Veuillez lire ce document avec attention et dans son intégralité.
- ▶ Veuillez suivre les instructions et les consignes de sécurité mentionnées dans ce document ainsi que sur le produit.
- ▶ N'utilisez le produit que si celui-ci est dans un état technique irréprochable, en pleine conscience des règles de sécurité et des risques encourus.
- ▶ Conservez ce produit sur et à proximité de l'appareil pour référence ultérieure et en cas de cession de l'appareil.

1.2 Utilisation conforme

Le produit a été conçu exclusivement pour une utilisation dans le domaine privé.

- ▶ Veuillez utiliser ce produit uniquement en tant qu'abri de jardin et à l'extérieur.
- ▶ N'utilisez le produit que lorsque celui-ci est complètement monté et installé de manière sécurisée sur une fondation.
- ▶ N'utilisez le produit que dans son état d'origine, avec les pièces d'origine fournies et/ou avec des pièces détachées autorisées par le fabricant.
- ▶ Ne confiez les réparations qu'à du personnel qualifié.

Toute autre utilisation est considérée comme non conforme et peut entraîner d'importants dommages corporels et matériels.

Nous déclinons toute responsabilité en cas de non-respect des instructions et des consignes de sécurité, d'une utilisation non conforme et de dommages corporels et matériels en résultant.

1.3 Utilisation non conforme

Le produit n'est pas conçu pour une utilisation à des fins commerciales.

Ce produit n'est pas un jouet.

- ▶ N'utilisez pas le produit avec des pièces défectueuses.
- ▶ Ne bloquez pas les ouvertures ni les accès.
- ▶ Ne bloquez pas la porte, celle-ci constitue également une issue de secours.
- ▶ Ne faites pas fonctionner ou ne stockez pas de sources de chaleur telles qu'un feu ou un barbecue à l'intérieur du produit.
- ▶ N'utilisez pas le produit à proximité de sources de chaleur, comme par exemple des barbecues, des appareils de chauffage, des bou-

gies ou des feux ouverts.

- ▶ Évitez de monter, de démonter et d'installer le produit en cas de fortes rafales, de pluie battante, d'orage ou de grêles.
- ▶ N'accrochez pas d'objets lourds au produit.
- ▶ Ne posez pas d'objets sur le produit.
- ▶ Ne montez pas sur le produit.
- ▶ Retirez immédiatement les masses de neige du toit. Risque d'effondrement.

1.4 Groupe cible

Les utilisateurs sont les adultes et les enfants à partir de 12 ans sous la surveillance d'un adulte, qui ont lu et compris ces instructions et les marquages sur le produit ou qui ont reçu une formation similaire relative à l'utilisation et aux consignes de sécurité.

Les personnes présentant des capacités physiques ou mentales réduites ne peuvent utiliser le produit que sous la surveillance d'un adulte.

Les travaux de montage, de maintenance et de nettoyage ne doivent pas être effectués par les personnes mentionnées ci-avant.

Les utilisateurs ne peuvent utiliser le produit que s'ils sont éveillés, sobres et en pleine possession de leurs capacités physiques, psychiques et sensorielles.

Le personnel qualifié représente les personnes ayant reçu une formation spécialisée dans les domaines mécanique/électrotechnique/hydraulique-pneumatique telles que les métallurgistes, électriciens, artisans qualifiés etc.

1.5 Niveaux d'avertissement

DANGER

Avertissement portant sur les dangers pouvant entraîner **directement la mort** ou de graves blessures en cas de non-respect des mesures.

AVERTISSEMENT

Avertissement portant sur les dangers pouvant entraîner **la mort ou de graves blessures** en cas de non-respect des mesures.

PRUDENCE

Avertissement portant sur les dangers pouvant entraîner des **blessures** en cas de non-respect des mesures.

ATTENTION

Avertissement portant sur les dangers pouvant entraîner des **dommages matériels** en cas de non-respect des mesures.

1.6 Symboles

Symboles	Description
	Ce symbole indique que l'utilisateur doit avoir lu et compris les instructions avant toute utilisation.
	Ce symbole indique que l'utilisateur doit porter des gants de protection lorsqu'il travaille sur le produit.
	Ce symbole indique que les travaux sur le produit doivent être effectués avec au moins une autre personne.
	Instructions de manipulation sans ordre à suivre.
	Le symbole international de recyclage indique que le matériau est recyclable.
	Ce symbole indique que l'utilisation de visseuses électriques est interdite.
	Le logo ECOEMBES est un symbole de recyclage obligatoire introduit en Espagne qui indique les produits et emballages recyclables devant être collectés séparément.
	Le logo Triman est un symbole de recyclage obligatoire en France pour le tri sélectif des déchets.

1.7 Instructions de sécurité

	AVERTISSEMENT! Risque d'incendie dû aux sources de chaleur. Le produit est composé de matériaux inflammables. ► Tenez le produit éloigné des sources de chaleur, telles que les barbecues, les radiateurs, les bougies ou les flammes nues.
	PRUDENCE Coup de chaleur! ► En cas de fortes températures et de forte humidité de l'air, ne restez à l'intérieur de l'appareil que pendant un court moment et sortez immédiatement en cas d'inconfort.
	PRUDENCE Blessures et dommages matériels. Une modification du produit peut entraîner des blessures et des dommages matériels et provoquer l'annulation de la garantie. ► N'utilisez le produit qu'avec les pièces d'origine fournies et dans son état d'origine. ► N'utilisez que des pièces de rechange autorisées par le fabricant.

	PRUDENCE Risque de blessure par coupure. ► Ne touchez pas à mains nues des pièces composées de matériaux brisés ou présentant des arêtes. ► Utilisez un équipement de protection et des outils adaptés.
--	--

FR

2. Description et fonctionnement

Ce produit est un abri de jardin destiné à une utilisation dans le jardin. Il offre une vaste surface de stockage pour le rangement d'outillage de jardin. Sa structure résistante et solide protège l'outillage des intempéries. L'abri de jardin a des parois très hautes pour faciliter l'accès et offrir plus d'espace de rangement et de liberté de mouvement. L'abri de jardin dispose également de deux grandes portes verrouillables et d'un système de drainage rapide intégré.

3. Déballage et contrôle

3.1 Déballer le produit

	AVERTISSEMENT! Risque d'étouffement dû au matériel d'emballage et à l'ingestion de petites pièces. ► Éliminez le matériel d'emballage de manière conforme dans la poubelle de déchets ménagers. ► Conservez les petites pièces hors de portée des enfants.
---	---

	ATTENTION Dommages matériels. Les objets pointus, coupants et provoquant des rayures peuvent endommager le produit lors de l'ouverture de l'emballage. ► N'utilisez pas d'objet pointu, coupant ou provoquant des rayures pour ouvrir l'emballage.
---	---

1. Retirez toutes les pièces du carton.
2. Placez les pièces les unes à côté des autres sur une surface dégagée, lisse et plane.
3. Contrôlez l'étendue de la livraison afin de vérifier son état complet et son intégrité, voir le chapitre „14. Liste des pièces“ à la page 33.

4. Choisir l'emplacement

PRUDENCE

Risque de blessures et de dégâts matériels.

- ▶ Installez le produit correctement et dans une position stable.
- ▶ Ne connectez pas 2 abris de jardin l'un à l'autre.

ATTENTION

Dommages matériels dus charges de neige.

Les charges de neige qui s'accumulent sur le toit du produit ou qui tombent sur le produit peuvent endommager le produit.

- ▶ Lors du choix du lieu d'installation, veillez à ce que :

1. le haut du produit soit facilement accessible pour le déneigement,
2. qu'il y ait le moins de risque possible de charges de neige et
3. que les charges de neige soient régulièrement et rapidement évacuées du produit lorsque les conditions météorologiques le permettent.

▶ Avant de choisir l'emplacement et les fondations, renseignez-vous sur les éventuelles règles et autorisations de construction auprès des autorités compétentes de votre Land.

▶ L'emplacement doit présenter les caractéristiques suivantes :

- Le sol est plan, sec et solide.
- La distance minimale de 3 m par rapport à l'abri de jardin le plus proche ainsi qu'aux autres constructions et aux limites de propriété est respectée.
- Il n'y a pas d'obstacles au-dessus du sol, par exemple des branches d'arbres ou des lignes électriques.

Remarque: Le matériel de montage pour la fixation de la base sur une fondation en bois n'est pas compris dans la livraison.

4.1 Installer la cabane à outils sur une fondation en bois

1. Fixez les supports de fondation par points de manière homogène à la structure en bois, par exemple plusieurs supports de poteaux.
2. Percez plusieurs trous pour les fondations par points.
3. Versez du gravier dans les trous et orientez la structure en bois à l'horizontale.
4. Versez du béton dans les trous et laissez le béton sécher.
5. Répartissez du sable ou du gravier sous la fondation pour éviter que l'humidité ne s'y accumule.

6. Montez les plinthes.
7. Suivez les étapes de montage illustrées en respectant les consignes de sécurité, voir „15. Montage“ à la page 38.

4.2 Installer la cabane à outils sur des dalles en béton

Remarque: pour fixer l'abri de jardin sur les dalles de béton, il faut utiliser 12x Ø 6x80 mm chevilles universelles. Celles-ci ne sont pas comprises dans la livraison.

Remarque: si les distances entre les trous ne sont pas connues, il convient de les déterminer et de les reporter à l'aide des plinthes.

1. Posez plusieurs dalles de béton sur le lieu d'installation choisi.
2. Enduisez les dalles de béton de boue.
3. Percez les trous nécessaires dans les dalles de béton à l'aide d'une mèche à pierre de Ø6 mm
4. Nettoyez les trous de perçage.
5. Enfoncez les chevilles dans les trous.
6. Montez les plinthes avec les vis fournies.
7. Suivez les étapes de montage illustrées en respectant les consignes de sécurité, voir „15. Montage“ à la page 38.

5. Montage

PRUDENCE

Dommages matériels.

Les étapes de montage suivantes doivent être effectuées sur la fondation à l'emplacement préalablement choisi afin d'éviter toute coupure et tout coincement et de ne pas endommager le produit pendant le transport.

- ▶ Pour la fixation de la base sur les dalles de béton, utilisez du matériel de montage adapté.

ATTENTION

Endommagement du produit dû à un montage incorrect.

- ▶ Assemblez le produit de manière complète et sûre.
- ▶ Assemblez le produit avec au minimum une deuxième personne.
- ▶ Vissez les vis à la main dans les orifices d'assemblage et ne serrez les vis que lors de la dernière étape afin d'empêcher tout coincement des pièces.

6. Transport

PRUDENCE

Risque de blessures et de dommages matériels dû à un transport inadapté.

- ▶ Ne transportez l'abri de jardin qu'à l'état démonté.
- ▶ Les corrections mineures de l'emplacement ne peuvent être effectuées qu'avec l'aide d'une deuxième personne et avec un équipement de protection.

7. Utiliser

PRUDENCE

Risque de blessures dû à une utilisation inadaptée.

- ▶ N'utilisez le produit que dans le respect de son utilisation conforme, voir le chapitre „1.2 Utilisation conforme“ à la page 16.

ATTENTION

Endommagement du produit dû à de fortes intempéries.

- ▶ En cas de vent, veuillez toujours maintenir les ouvertures (portes, fenêtres) fermées.

8. Démontage

- ▶ Démontez le produit dans l'ordre inverse de l'ordre mentionné dans le chapitre „15. Montage“ à la page 38.

9. Stockage

ATTENTION

Dommages matériels dus à un stockage non adapté.

- ▶ Stockez le produit à l'état démonté un endroit sec et propre.
- ▶ Protégez le produit de la poussière et de l'humidité.
- ▶ Ne posez pas d'objets sur le produit en raison de déformations qui pourraient se produire.

10. Nettoyage et maintenance

10.1 Nettoyage

ATTENTION

Endommagement dû à un produit de nettoyage non adapté.

- ▶ Vérifiez la compatibilité du produit de nettoyage avec la surface à un emplacement peu visible.
- ▶ Pour le nettoyage, n'utilisez pas de solvant organique, d'eau bouillante, d'acides forts ou de nettoyant alcalin.

- ▶ Éliminez la poussière et les légères salissures à l'aide d'un chiffon humide ou d'une brosse douce.
- ▶ En cas de salissures importantes, utilisez un nettoyant doux, non inflammable et compatible avec les produits alimentaires ou un chiffon imbibé d'eau.
- ▶ Retirez rapidement et régulièrement les excréments d'animaux, les feuilles, la neige et les autres salissures grossières du toit du produit.
- ▶ Lubrifiez la surface de roulement et les pièces mobiles de la porte à l'aide d'un peu de spray lubrifiant.

10.2 Plan de maintenance

Une maintenance régulière augmente la sécurité et la longévité de votre produit.

Avant chaque utilisation

État

- ▶ Contrôlez l'état général du produit pour vérifier l'absence de dommages.

Pièces de fixation

- ▶ Contrôlez si des pièces de fixation sont devenues lâches ou déformées, fixez-les à nouveau si nécessaire.

11. Réparation

ATTENTION

Endommagement dû à une réparation non adaptée.

- ▶ N'utilisez que des pièces de rechange d'origine ou autorisées par le fabricant.
- ▶ Faites réaliser les réparations par du personnel qualifié.

12. Données techniques

Désignation	Valeur
Matériau abri de jardin :	tôle galvanisée à chaud
Matériau poignée de porte :	plastique
Dimensions (largeur x profondeur x hauteur)	
Dimensions extérieures :	396x294x220 cm
Dimensions intérieures :	389x287x190 cm
Porte :	110x180 cm
Poids :	165 kg

13. Élimination



Étiquette Triman : Le logo indique que le produit ou l'emballage est recyclable et doit être éliminé séparément. Pour un recyclage optimal, jetez les différents composants du produit ou de l'emballage séparément. Le logo en trois parties aide les consommateurs au tri et leur fournit des instructions sur la manière de trier leurs déchets dans les différents conteneurs de recyclage ou de recyclage, par exemple pour le verre, le papier, le plastique, etc. Ces conteneurs sont disponibles auprès des associations locales, des commerçants ou des déchetteries. Seuls les produits sans le logo Triman doivent être jetés avec les déchets ménagers. Pour les meubles, les lits, les articles de jardin et les jouets, des réglementations plus strictes concernant la réutilisation et le recyclage peuvent être appliquées par Ecomaison.

Tabella dei contenuti

1. Per la vostra sicurezza	22
1.1 Per la vostra sicurezza.....	22
1.2 Utilizzare in modo conforme.....	22
1.3 Uso improprio.....	22
1.4 Gruppo target.....	22
1.5 Livelli di avvertimento.....	22
1.6 Simboli.....	23
1.7 Avvertenze di sicurezza.....	23
2. Descrizione e funzione	23
3. Disimballaggio e verifica	23
3.1 Disimballare il prodotto.....	23
4. Selezionare la posizione	24
4.1 Installare la casetta degli attrezzi sulle fondamenta in legno.....	24
4.2 Installazione la casetta degli attrezzi su lastre di cemento.....	24
5. Montaggio	24
6. Trasporto	25
7. Utilizzo	25
8. Smontaggio	25
9. Stoccaggio	25
10. Pulizia e manutenzione	25
10.1 Pulizia.....	25
10.2 Piano di manutenzione.....	25
11. Riparazioni	25
12. Dati tecnici	26
13. Smaltimento	26
13.1 Confezione.....	26
13.2 Informazioni generali sul prodotto.....	26
14. Elenco parti	33
15. Montaggio	38

1. Per la vostra sicurezza

1.1 Per la vostra sicurezza

- ▶ Leggere il presente documento con attenzione e integralmente.
- ▶ Seguire le istruzioni e le avvertenze per la sicurezza riportate nel documento e sul prodotto.
- ▶ Utilizzare il prodotto solo se in condizioni tecniche perfette e con consapevolezza in termini di rischio e pericolo.
- ▶ Conservare questo documento nei pressi del prodotto come futuro riferimento e per il passaggio ad altri.

1.2 Utilizzare in modo conforme

Il prodotto è stato sviluppato esclusivamente per l'uso privato.

- ▶ Utilizzare il prodotto esclusivamente come rimessa attrezzi da esterno.
- ▶ Utilizzare il prodotto solo se interamente montato e assicurato su una base.
- ▶ Utilizzare il prodotto solo in stato originale, servendosi unicamente dei pezzi originali forniti in dotazione e/o di ricambi autorizzati dal produttore.
- ▶ Far eseguire le riparazioni solo da personale specializzato.

Qualsiasi utilizzo differente sarà considerato un uso improprio e può comportare gravi danni a persone e cose.

Decliniamo qualsiasi responsabilità in caso di inosservanza delle istruzioni, delle avvertenze sulla sicurezza, di uso improprio e per i relativi danni causati a persone e cose.

1.3 Uso improprio

Il prodotto non è pensato per l'impiego in ambito commerciale.

Questo prodotto non è un giocattolo.

- ▶ Non utilizzare il prodotto con parti difettose.
- ▶ Non bloccare aperture e accessi.
- ▶ Non bloccare la porta: questa serve come via di fuga.
- ▶ Non gestire né conservare fonti di calore, come fuoco o griglie, all'interno del prodotto.
- ▶ Non utilizzare il prodotto nei pressi di fonti di calore, come apparecchi per grigliare, riscaldatori, candele o fiamme vive.
- ▶ Evitare il montaggio, lo smontaggio e l'installazione del prodotto in caso di forti raffiche di vento, forte pioggia, maltempo o grandine.
- ▶ Non appendere oggetti pesanti sul prodotto.

▶ Non collocare alcun oggetto pesante sul prodotto.

▶ Non posizionarsi sopra al prodotto.

▶ Rimuovere subito le masse di neve dal tetto. Sussiste un pericolo di crollo.

1.4 Gruppo target

Gli utenti sono adulti e i bambini a partire da 12 anni, sotto la supervisione di un adulto, che abbiano letto e compreso le presenti istruzioni e i contrassegni riportati sul prodotto o che abbiano ottenuto istruzioni paragonabili in merito all'uso e alle avvertenze per la sicurezza.

Le persone con abilità fisiche o mentali ridotte possono utilizzare il prodotto solo sotto la supervisione di un utente adulto.

I lavori di montaggio, manutenzione e pulizia non possono essere eseguiti dai soggetti summenzionati.

Gli utenti possono utilizzare il prodotto solo nel pieno possesso delle proprie abilità fisiche, psichiche e sensoriali, in condizioni di piena vigilanza e sobrietà.

Il personale specializzato include persone con una formazione in ambito meccanico/elettrotecnico/idraulico-pneumatico, come artigiani qualificati, metalmeccanici, elettricisti, ecc.

1.5 Livelli di avvertimento

PERICOLO

Avvertimento di pericoli che, in caso di inosservanza delle misure, comportano la morte immediata o gravi lesioni.

AVVERTENZA

Avvertimento di pericoli che, in caso di inosservanza delle misure, possono comportare la morte o gravi lesioni.

CAUTELE

Avvertimento di pericoli che, in caso di inosservanza delle misure, possono comportare delle lesioni.

ATTENZIONE



Avvertimento di pericoli che, in caso di inosservanza delle misure, possono comportare dei danni materiali.

1.6 Simboli

Symbolo	Designazione
	Questo simbolo indica che l'utente deve aver letto e compreso le istruzioni prima dell'uso.
	Questo simbolo indica che l'utente deve indossare dei guanti protettivi quando utilizza il prodotto.
	Questo simbolo indica che, per eseguire lavori sul prodotto, è richiesta la presenza di almeno un'altra persona.
	Istruzioni non sequenziali.
	Il simbolo internazionale di riciclaggio indica la presenza di materiali riutilizzabili.
	Questo simbolo indica che l'uso di avvitatori elettrici è proibito.
	Il logo ECOEMBES è un simbolo di riciclaggio obbligatorio per legge, introdotto in Spagna, che indica i prodotti e gli imballaggi riciclabili che devono essere raccolti separatamente.
	Il logo Triman è un simbolo di riciclaggio obbligatorio in Francia per la raccolta differenziata dei rifiuti.

1.7 Avvertenze di sicurezza

	AVVERTENZA
	Pericolo di incendio dovuto a fonti di calore. Il prodotto è composto da materiali infiammabili. ► Tenere il prodotto lontano da fonti di calore come barbecue, stufe radianti, candele o fuochi aperti.
	CAUTELE
	Colpo di calore! ► In caso di alte temperature e un livello di umidità dell'aria elevato, trattenersi solo a breve all'interno del prodotto e lasciarlo subito in caso di malessere.
	CAUTELE
	Lesioni e danni materiali. La modifica del prodotto può causare lesioni e danni materiali e portare alla decadenza della garanzia legale. ► Utilizzare il prodotto solo nello stato originale e con le parti originali fornite in dotazione. ► Utilizzare solo ricambi autorizzati dal produttore.

	CAUTELE
	Pericolo di lesione da taglio. ► Non toccare parti come materiali rotti o sbavati a mani nude. ► Utilizzare dispositivi di protezione e utensili adeguati.



2. Descrizione e funzione

Questo prodotto è una rimessa attrezzi per il giardino. Essa offre un'ampia superficie di deposito per la conservazione di attrezzi per il giardino. Grazie ad una struttura stabile e resistente, questi sono protetti dagli influssi meteorologici. Il capannone è dotato di pareti più alte per facilitare l'accesso e offrire maggiore spazio di stoccaggio e libertà di movimento. Il capannone è inoltre dotato di due ampie porte con serratura e di un sistema integrato di drenaggio rapido dell'acqua piovana.

3. Disimballaggio e verifica

3.1 Disimballare il prodotto

	AVVERTENZA
	Pericolo di soffocamento dovuto al materiale della confezione e all'ingerimento di pezzi piccoli. ► Smaltire il materiale della confezione nei rifiuti domestici in conformità alle norme applicabili. ► Conservare le parti piccole fuori dalla portata dei bambini.

	ATTENZIONE
	Danni materiali. Gli oggetti appuntiti e graffianti possono danneggiare il prodotto all'apertura della confezione. ► Non utilizzare oggetti appuntiti, affilati o graffianti per aprire la confezione.

1. Rimuovere tutte le parti dal cartone.
2. Posizionare le parti una accanto all'altra su una superficie libera, morbida e piana.
3. Verificare l'integrità e la completezza del volume di consegna, vedere il capitolo „14. Elenco parti“ a pagina 33.

4. Selezionare la posizione

 **CAUTELA**

Rischio di lesioni e danni materiali.

- ▶ Installare il prodotto in modo corretto e in posizione stabile.
- ▶ Non collegare 2 cassette da giardino tra loro.

ATTENZIONE

Danni materiali dovuti a carichi di neve.

I carichi di neve che si accumulano sul tetto del prodotto o che cadono sul prodotto possono danneggiarlo.

- ▶ Quando si sceglie il luogo di installazione, assicurarsi che:

1. la parte superiore del prodotto sia facilmente accessibile per la rimozione della neve,
2. il rischio di carichi di neve sia il più basso possibile e
3. il rischio di carichi di neve sia il più basso possibile e che i carichi di neve vengano regolarmente e tempestivamente rimossi dal prodotto in condizioni atmosferiche adeguate.

▶ Prima di scegliere la sede e la base, informarsi sulle norme edilizie pertinenti e sugli eventuali permessi di costruzione necessari presso l'autorità di competenza nel proprio Paese.

▶ La sede deve presentare le seguenti caratteristiche:

- il fondo è piano, asciutto e rigido.
- Sul fondo non si trovano ostacoli, come rami di alberi o linee di alimentazione elettrica.
- La distanza minima di 3 m dalla rimessa attrezzi successiva, da altri fabbricati e dai confini del fondo viene rispettata.

Avvertenza: Il materiale di montaggio per fissare la base a un basamento in legno non è incluso nella fornitura.

4.1 Installare la cassetta degli attrezzi sulle fondamenta in legno

1. Fissare i supporti per fondazioni puntuali in modo omogeneo sul telaio di legno, ad esempio diversi supporti per pali.
2. Praticare più fori per le fondazioni puntuali.
3. Versare ghiaia nei fori e allineare orizzontalmente il telaio in legno.
4. Versare il calcestruzzo nei fori e far asciugare il calcestruzzo.
5. Distribuire sabbia o ghiaia sotto la fondazione affinché non vi si accumuli umidità.

6. Montare le modanature del pavimento.
7. Seguire i passaggi di montaggio raffigurati osservando le avvertenze per la sicurezza, vedi „15. Montaggio“ a pagina 38.

4.2 Installazione la cassetta degli attrezzi su lastre di cemento

Nota: per fissare la cassetta alle lastre di cemento sono necessari 12 tasselli universali Ø 6x80 mm. Non sono compresi nella fornitura.

Nota: se le distanze tra i fori non sono note, è necessario determinarle e trasferirle utilizzando le modanature del pavimento.

1. Posare diverse lastre di cemento nel luogo di installazione prescelto.
2. Spatolare le lastre di calcestruzzo.
3. Praticare i fori necessari nelle lastre di cemento con una punta da muratore di Ø 6 mm.
4. Pulire i fori.
5. Premere i tasselli nei fori.
6. Montare i battiscopa con le viti in dotazione.
7. Seguire i passaggi di montaggio raffigurati osservando le avvertenze per la sicurezza, vedi „15. Montaggio“ a pagina 38.

5. Montaggio

 **CAUTELA**

Danni materiali.

I seguenti passaggi di montaggio dovrebbero essere eseguiti sulla fondazione nella sede scelta in precedenza per evitare tagli e schiacciamenti e per non danneggiare il prodotto durante il trasporto.

- ▶ Per il fissaggio della base alle lastre di calcestruzzo, utilizzare un materiale di montaggio adeguato.

ATTENZIONE

Danneggiamento del prodotto dovuto ad un montaggio errato.

- ▶ Montare il prodotto in modo completo e sicuro.
- ▶ Montare il prodotto servendosi dell'aiuto di almeno una seconda persona.
- ▶ Avvitare prima a mano le viti nei fori di collegamento e serrarle poi alla fine per impedire un ribaltamento delle parti.

6. Trasporto

CAUTELA

Pericolo di lesioni e danni materiali dovuti ad un trasporto errato.

- ▶ Trasportare la rimessa attrezzi solo smontata.
- ▶ Eseguire correzioni minime della posizione solo dietro l'assistenza di una seconda persona e utilizzando dei dispositivi di protezione.

7. Utilizzo

CAUTELA

Pericolo di lesioni dovute ad un uso improprio.

- ▶ Utilizzare il prodotto in modo conforme, vedere il capitolo „1.2 Utilizzare in modo conforme“ a pagina 22.

ATTENZIONE

Danneggiamento del prodotto dovuto ad un forte maltempo.

- ▶ Tenere le aperture, come porte o finestre, sempre chiuse in presenza di vento.

8. Smontaggio

- ▶ Smontare il prodotto in sequenza inversa rispetto a quella descritta al capitolo „15. Montaggio“ a pagina 38.

9. Stoccaggio

ATTENZIONE

Danni materiali causati da una conservazione errata.

- ▶ Conservare il prodotto smontato in un luogo asciutto e pulito.
- ▶ Proteggere il prodotto da polvere e umidità.
- ▶ Non collocare oggetti sul prodotto per evitare che si deformi.

10. Pulizia e manutenzione

10.1 Pulizia

ATTENZIONE

Danni dovuti a detergenti errati.

- ▶ Verificare la compatibilità dei detergenti con la superficie in un punto non esposto.
- ▶ Per la pulizia non utilizzare solventi organici, acqua bollente, acidi forti o detergenti alcalini.

- ▶ Rimuovere la polvere e lo sporco lieve con un panno umido o una spazzola morbida.
- ▶ In caso di sporco ostinato, utilizzare un detergente delicato, non infiammabile e sicuro per gli alimenti o un panno inumidito con acqua.
- ▶ Rimuovere subito e regolarmente gli escrementi di animali, foglie, neve e altro sporco grossolano dal tetto del prodotto.
- ▶ Lubrificare il battistrada e le parti mobili della porta con una piccola quantità di grasso spray.

10.2 Piano di manutenzione

La regolare manutenzione aumenta la sicurezza e la longevità del vostro prodotto.

Prima di ogni utilizzo

Stato

- ▶ Controllare le condizioni generali del prodotto e l'eventuale presenza di danni.

Parti annesse

- ▶ Controllare se le parti annesse siano allentate o si siano spostate e fissarle di nuovo secondo le esigenze.

11. Riparazioni

ATTENZIONE

Danni dovuti a riparazioni improprie.

- ▶ Utilizzare solo ricambi originali o autorizzati dal produttore.
- ▶ Far eseguire le eventuali riparazioni necessarie unicamente da un personale specializzato.

12. Dati tecnici

Denominazione	Valore
Materiale rimessa attrezzi:	zincata a caldo lamiera d'acciaio
Materiale della maniglia della porta:	plastica
Dimensioni (larghezza x profondità x altezza)	
Dimensioni esterne:	396x294x220 cm
Dimensioni interne:	389x287x190 cm
Porta:	110x180 cm
Peso:	165 kg

13. Smaltimento

13.1 Confezione

Il materiale della confezione è riutilizzabile.

- Smaltire la confezione nel rispetto dell'ambiente e portarla alla raccolta regionale dei materiali riciclabili.

13.2 Informazioni generali sul prodotto

Questo prodotto non va smaltito nei rifiuti domestici. Alla fine del suo ciclo di vita, restituirlo gratuitamente al produttore, al punto vendita o portarlo ai centri di raccolta pubblici appositamente allestiti. I dettagli sulle modalità di smaltimento sono regolati dalla rispettiva legge nazionale. I materiali riciclabili vengono immessi nel ciclo di riciclaggio per ricavare nuove materie prime. I seguenti materiali riciclabili vengono raccolti nei centri di raccolta comunali:

- rifiuti di vetro, plastica, rottami metallici, lamiere e molto altro.

Con questo tipo di riciclaggio di vecchi prodotti, forniamo un contributo importante alla tutela del nostro ambiente.

Contenido

1. Por su seguridad	28
1.1 Por su seguridad	28
1.2 Uso previsto	28
1.3 Uso inadecuado	28
1.4 Grupo destinatario	28
1.5 Niveles de advertencia	28
1.6 Símbolos	29
1.7 Indicaciones de seguridad	29
2. Descripción y funcionamiento	29
3. Desembalaje y comprobación	29
3.1 Desembalar el producto	29
4. Seleccionar emplazamiento	30
4.1 Instalar la caseta de herramientas sobre cimientos de madera	30
4.2 Instalar la caseta de herramientas sobre losa de hormigón	30
5. Montaje	30
6. Transporte	31
7. Utilice	31
8. Desmontaje	31
9. Almacenamiento	31
10. Limpieza y mantenimiento	31
10.1 Limpieza	31
10.2 Plan de mantenimiento	31
11. Reparaciones	31
12. Datos técnicos	32
13. Eliminación de residuos	32
13.1 Embalaje	32
13.2 El producto en general	32
14. Lista de piezas	33
15. Montaje	38

1. Por su seguridad

1.1 Por su seguridad

- ▶ Lea este documento de principio a fin con atención.
- ▶ Siga las instrucciones y las indicaciones de seguridad que figuran en este documento y en el producto.
- ▶ Utilice el producto solo en perfectas condiciones técnicas, prestando atención a su seguridad y a los posibles riesgos.
- ▶ Conserve este documento cerca del producto para consultarlo en futuras ocasiones y para pasárselo al siguiente usuario.

1.2 Uso previsto

El producto está concebido exclusivamente para un uso privado.

- ▶ Utilice el producto exclusivamente como caseta de herramientas en exteriores.
- ▶ Use el producto solamente cuando esté montado por completo e instalada con seguridad sobre unos cimientos.
- ▶ Utilice el producto únicamente en su estado original, con las piezas originales suministradas y/o con las piezas de repuesto autorizadas por el fabricante.
- ▶ Asegúrese de que las reparaciones las lleva a cabo personal cualificado.

Cualquier otro uso se considerará inadecuado y podrá conllevar daños personales y materiales.

No asumimos responsabilidad alguna en caso de no seguir las instrucciones e indicaciones de seguridad o de hacer un uso inadecuado, ni por los daños personales y materiales resultantes.

1.3 Uso inadecuado

El producto no es apropiado para usarlo con fines comerciales.

El producto no es un juguete.

- ▶ No utilice el producto con piezas defectuosas.
- ▶ No bloquee ninguna abertura o acceso.
- ▶ No bloquee la puerta; funciona como salida de emergencia.
- ▶ No encienda ni guarde ninguna fuente de calor, como fuego o barbacoas, en el interior del producto.
- ▶ No utilice el producto en las proximidades de fuentes de calor, como barbacoas, calefactores, velas o llamas abiertas.
- ▶ Evite montar, desmontar e instalar el producto si hay rachas de viento fuertes, lluvia intensa o tormenta, o granizo.

- ▶ No cuelgue ningún objeto pesado del producto.
- ▶ No apoye ningún objeto sobre el producto.
- ▶ No se apoye sobre el producto.
- ▶ Retire al instante la nieve acumulada sobre el tejado. Se corre el riesgo de derumbamiento.

1.4 Grupo destinatario

Los usuarios son adultos y niños de más de 12 años bajo supervisión de un adulto, que hayan leído y comprendido este manual y los símbolos que aparecen en el producto o que hayan recibido instrucciones equivalentes sobre el uso y las indicaciones de seguridad.

Las personas con alguna discapacidad física o intelectual solo pueden utilizar el producto bajo supervisión de un usuario adulto.

Las personas anteriormente indicadas no pueden encargarse de las tareas de montaje, mantenimiento y limpieza.

Los usuarios solo pueden utilizar el producto si están en plena posesión de sus facultades físicas, mentales y sensoriales, además de despiertos y sobrios.

Por personal cualificado se entiende aquellas personas con una formación especializada en el ámbito mecánico/electrotécnico/hidráulico-neumático, como mecánicos, trabajadores del metal, electricistas, etc.

1.5 Niveles de advertencia

PELIGRO

Advertencia frente a peligros que causan directamente la muerte o lesiones graves en caso de no seguir las instrucciones.

ATENCIÓN

Advertencia frente a peligros que pueden causar la muerte o lesiones graves en caso de no seguir las instrucciones.

CUIDADO

Advertencia frente a peligros que pueden causar lesiones en caso de no seguir las instrucciones.

AVISO



Advertencia frente a peligros que pueden causar daños materiales en caso de no seguir las instrucciones.

1.6 Símbolos

Símbolo	Descripción
	Este símbolo indica que el usuario debe haber leído y comprendido el manual antes de utilizar el producto.
	Este símbolo indica que el usuario debe llevar guantes protectores al realizar trabajos en los que se manipule el producto.
	Este símbolo indica que el usuario debe llevar guantes protectores al realizar trabajos en los que se manipule el producto.
	Instrucciones no relacionadas con la secuencia.
	El símbolo de reciclaje internacional indica que el material es reaprovechable.
	Este símbolo indica que está prohibido utilizar tornillos eléctricos.
	El logotipo ECOEMBES es un símbolo de reciclaje obligatorio por ley, introducido en España, que indica los productos y envases reciclables que deben recogerse de forma selectiva.
	El logotipo Triman es un símbolo de reciclaje obligatorio en Francia para la separación de residuos a nivel local.

1.7 Indicaciones de seguridad

	ATENCIÓN Riesgo de incendio por fuentes de calor. El producto contiene materiales inflamables.  ▶ Mantenga el producto alejado de fuentes de calor como barbacoas, calefactores radiantes, velas o fuegos abiertos.
	CUIDADO ¡Insolación!  No permanezca durante mucho tiempo en el interior del producto si las temperaturas y la humedad del aire son elevadas y salga de inmediato si comienza a encontrarse mal.
	CUIDADO Lesiones y daños materiales. La modificación del producto puede provocar lesiones y daños materiales, así como la anulación de la garantía.  ▶ Utilice el producto únicamente en su estado original y con las piezas originales suministradas. ▶ Utilice exclusivamente las piezas de repuesto autorizadas por el fabricante.



	CUIDADO Riesgo de lesiones por cortes.  ▶ No agarre con las manos descubiertas piezas tales como materiales partidos o con rebabas. ▶ Utilice las herramientas y el equipo de protección apropiados.
--	--

2. Descripción y funcionamiento

Este producto es una caseta de herramientas para el jardín. Ofrece una amplia superficie para almacenar herramientas de jardinería. Gracias a su estructura resistente y estable, estas estarán protegidas frente a las inclemencias meteorológicas. El cobertizo tiene paredes extra altas para facilitar el acceso y proporcionar más espacio de almacenamiento y libertad de movimientos. El cobertizo también tiene dos grandes puertas con cerradura y un sistema integrado de drenaje rápido del agua de lluvia.

3. Desembalaje y comprobación

3.1 Desembalar el producto

	ATENCIÓN Riesgo de asfixia con el material de embalaje y por la ingesta de piezas pequeñas.  ▶ Deseche el material de embalaje conforme a la normativa aplicable junto con los residuos domésticos. ▶ Mantenga las piezas pequeñas fuera del alcance de los niños.
--	--

	AVISO Daños materiales. Los objetos puntiagudos, afilados o que puedan rayar superficies pueden dañar el producto al abrir el embalaje. ▶ Al abrir el embalaje, no utilice ningún objeto puntiagudo, afilado o que pueda rayar superficies.
---	--

1. Extraiga todas las piezas de la caja.
2. Deposite las piezas una junto a otra sobre una superficie despejada, suave y plana.
3. Compruebe que el envío está completo y no tiene desperfectos; véase el capítulo „14. Lista de piezas“ en la página 33.

4. Seleccionar emplazamiento

⚠ CUIDADO

Riesgo de lesiones y daños materiales.

- ▶ Coloque el producto correctamente y en una posición estable.
- ▶ No conecte 2 casetas de jardín entre sí.

ⓘ AVISO

Daños materiales debidos a cargas de nieve.
Las cargas de nieve que se acumulan en el techo del producto o caen sobre él pueden dañarlo.

- ▶ Al seleccionar el lugar de instalación, asegúrese de que:

1. la parte superior del producto sea fácilmente accesible para retirar la nieve,
2. el riesgo de cargas de nieve sea lo más bajo posible y
3. las cargas de nieve se retiren periódica y rápidamente del producto en condiciones meteorológicas adecuadas.

▶ Antes de escoger la ubicación y los cimientos, consulte a las autoridades competentes de su región para informarse de las posibles normativas y licencias de construcción aplicables.

▶ La ubicación debe cumplir las siguientes características:

- la superficie de apoyo es plana y firme y está seca,
- Sobre la superficie de apoyo no hay ningún obstáculo, como ramas de árboles o cables eléctricos,
- Existe una distancia mínima de 3 m respecto a la caseta de herramientas más próxima u otras edificaciones y delimitaciones de terrenos.

Aviso: El material de montaje para fijar la base a un cimiento de madera no está incluido en el volumen de suministro.

4.1 Instalar la caseta de herramientas sobre cimientos de madera

1. Fije uniformemente los soportes de los bloques de cimentación al amazón de madera, por ejemplo, varios soportes para postes.
2. Cave varios hoyos para los bloques de cimentación.
3. Eche grava en los hoyos y coloque el amazón de madera en horizontal.
4. Vierta hormigón en los hoyos y deje que fragüe.
5. Esparza arena o grava por debajo de los cimientos para que no se acumule humedad por debajo de estos.
6. Coloque las molduras del suelo.

7. Siga los pasos de montaje mostrados en las imágenes, atendiendo a las indicaciones de seguridad; véase el capítulo „15. Montaje“ en la página 38.

4.2 Instalar la caseta de herramientas sobre losa de hormigón

Nota: para fijar la caseta a las losas de hormigón se necesitan 12 tacos universales Ø 6x80 mm. No están incluidos en el volumen de suministro.

Nota: Si no se conocen las distancias entre los orificios, éstas deberán determinarse y transferirse utilizando las molduras del suelo.

1. Coloque varias losas de hormigón en el lugar de instalación elegido.
2. Aplique lechada a las losas de hormigón.
3. Taladre los orificios necesarios en las losas de hormigón con una broca de albañilería de Ø6 mm.
4. Limpie los orificios.
5. Introduzca a presión los tacos en los orificios.
6. Coloque los rodapiés con los tornillos suministrados.
7. Siga los pasos de montaje mostrados en las imágenes, atendiendo a las indicaciones de seguridad; véase el capítulo „15. Montaje“ en la página 38.

5. Montaje

⚠ CUIDADO

Daños materiales.

Los siguientes pasos de montaje deben llevarse a cabo ya sobre los cimientos colocados en la ubicación previamente escogida, a fin de evitar cortes y contusiones y no dañar el producto durante su traslado.

- ▶ Utilice el material de montaje apropiado para fijar la base a las losas de hormigón.

ⓘ AVISO

Daños en el producto debido a un montaje erróneo.

- ▶ Monte el producto por completo y de forma segura.
- ▶ Monte el producto con ayuda de otra persona, como mínimo.
- ▶ Enrosque los tornillos con firmeza en los orificios de unión, pero no los apriete hasta el último paso para evitar que las piezas queden colocadas en una posición incorrecta.

6. Transporte

⚠ CUIDADO

Riesgo de lesiones y daños materiales debido a un traslado inadecuado.

- ▶ Traslade la caseta de herramientas solamente desmontada.
- ▶ Las pequeñas rectificaciones en el lugar de la instalación solo pueden llevarse a cabo con ayuda de otra persona y con equipo de protección.

7. Utilice

⚠ CUIDADO

Riesgo de lesiones debido a un uso inadecuado.

- ▶ Utilice el producto conforme a su uso previsto; véase el capítulo „1.2 Uso previsto“ en la página 28.

ℹ AVISO

Daños en el producto debido a inclemencias meteorológicas extremas.

- ▶ Mantenga siempre cerradas las aberturas tales como puertas y ventanas en caso de que haya viento.

8. Desmontaje

- ▶ Desmonte el producto siguiendo el orden inverso al descrito en el capítulo „15. Montaje“ en la página 38.

9. Almacenamiento

ℹ AVISO

Daños materiales debido a un almacenamiento incorrecto.

- ▶ Almacene el producto desmontado un lugar limpio y seco.
- ▶ Proteja el producto frente al polvo y la humedad.
- ▶ No coloque objetos sobre el producto por deformación.

10. Limpieza y mantenimiento

10.1 Limpieza

ℹ AVISO

Daños en caso de usar productos de limpieza inadecuados.

- ▶ Asegúrese de que el producto de limpieza sea apto para la superficie del objeto haciendo una prueba en un punto no visible.
- ▶ No utilice para limpiar disolventes orgánicos, agua hirviendo, ácidos fuertes ni limpiadores alcalinos.

- ▶ Limpie el polvo y la suciedad leve con un paño humedecido o un cepillo suave.
- ▶ Si el producto presenta suciedad más persistente, utilice un limpiador suave, no inflamable y apto para el uso alimentario, o un paño humedecido con agua.
- ▶ Retire regularmente y de inmediato del tejado del producto los excrementos de animales, las hojas secas, la nieve y la suciedad tosca de cualquier otro tipo.
- ▶ Engrase la superficie de rodadura y las partes móviles de la puerta con espray lubricante.

10.2 Plan de mantenimiento

Un mantenimiento regular incrementa la seguridad y la durabilidad del producto.

Antes de cada uso

Estado

- ▶ Compruebe el estado general del producto y si presenta algún daño.

Piezas

- ▶ Compruebe si las piezas se han aflojado o deformado y fíjelas de nuevo en caso necesario.

11. Reparaciones

ℹ AVISO

Daños debido a una reparación inadecuada.

- ▶ Utilice exclusivamente piezas de repuesto originales o autorizadas por el fabricante.
- ▶ Asegúrese de que las reparaciones las lleva a cabo personal cualificado.

12. Datos técnicos

Concepto	Valor
Material caseta de herramientas:	galvanizado en caliente chapa de acero
Material de la manilla de la puerta:	plástico
Dimensiones (largo x ancho x alto)	
Dimensiones exteriores:	396x294x220 cm
Dimensiones interiores:	389x287x190 cm
Puerta:	110x180 cm
Peso:	165 kg

13. Eliminación de residuos

13.1 Embalaje

El material de embalaje es reprovechable.

- Deseche el material de embalaje conforme a la normativa ambiental y dépositelo en los contenedores de reciclaje de su entorno.

13.2 El producto en general































Este producto no se desecha junto con los residuos domésticos. Al término de su vida útil, puede devolverlo gratuitamente entregándoselo al fabricante, en el punto de venta o en un punto de recogida oficial previsto para ello. Los detalles sobre la eliminación de residuos dependen de las correspondientes leyes regionales. Los materiales aprovechables del producto se introducen en el ciclo de reciclaje para, a partir de ellos, obtener nuevas materias primas. Los siguientes materiales se pueden depositar en los puntos de recogida municipales:































- vidrio, plásticos, metales; chapa; etc.





























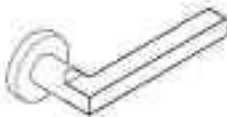





Gracias a este aprovechamiento de los productos usados estará realizando una importante contribución a la protección del medio ambiente.

14. Teilleste / Part list / Liste des pièces / Elenco parti / Lista de piezas

DE
EN
FR
IT
ES

1  x2	2  x2	3L  x1	3R  x1	4A  x4
4L  x1	4R  x1	7  x1	7A  x1	8  x1
8A  x1	9  x2	9A  x2	10  x4	10L  x1
10LA  x1	10R  x1	10RA  x1	11  x2	11A  x2
12  x4	13  x2	13A  x2	14  x2	15  x2
15L  x1	15LA  x1	15R  x1	15RA  x1	16L  x1

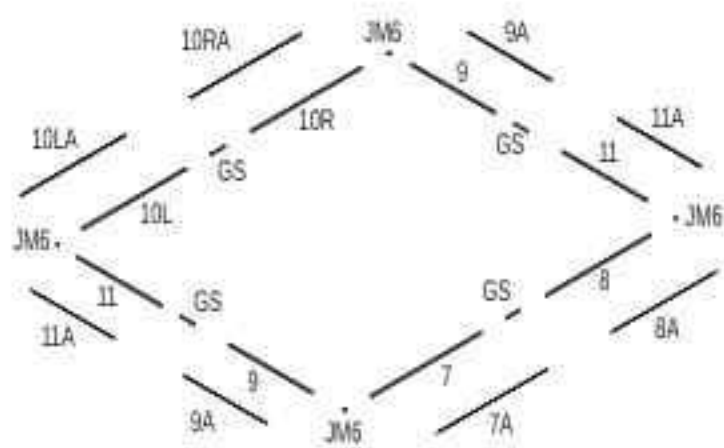
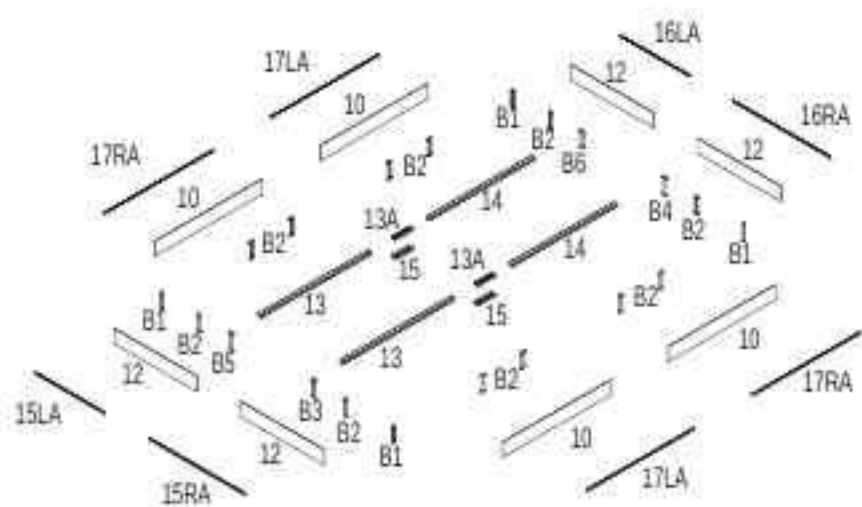
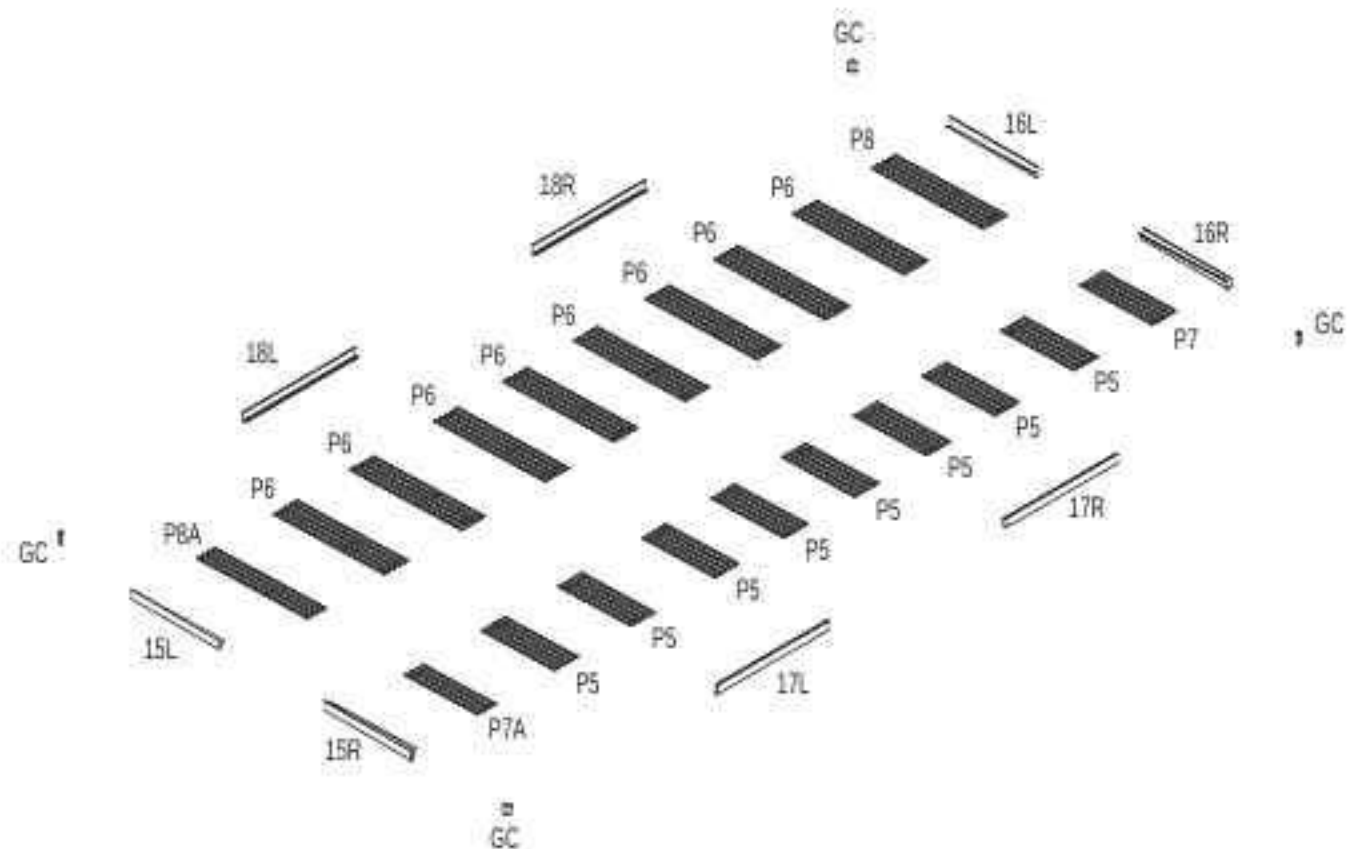

16LA  x1	16R  x1	16RA  x1	17L  x1	17LA  x2
17R  x1	17RA  x2	18L  x1	18R  x1	20  x2
20D  x1	20U  x1	20L  x1	20R  x1	21L  x1
21R  x1	22  x2	23  x2	24L  x1	24R  x1
25L  x1	25R  x1	B1  x4	B2  x12	B3  x1
B4  x1	B5  x1	B6  x1	DLA  x1	DRA  x1

P2A  x4	P3A  x20	P4A  x2	P5  x8	P6  x8
P7  x1	P7A  x1	P8  x1	P8A  x1	GC  x4
GR  x3	GS  x4	JM5  x4	JM6  x8	DC  x2
DH  x4	S04  x1	S05  x1	S06  x1	S07  x1
S13  x4	S14  x1	ST  x1	SX  x1	F1  x1
S1  x8	S2  x8	F2  M4x10 mm x4	F3  M4x40 mm x1	F6  M4x10 mm x2
 x8	 x8	M4X30  M4x30 mm x4	M4X40  M4x40 mm x1	M4X10  M4x10 mm x2



15. Montieren / Assembly / Montage / Montaggio / Montaje

1

Parts	No	Qty
 1	1	2
 2	2	2
 F1	F1	6

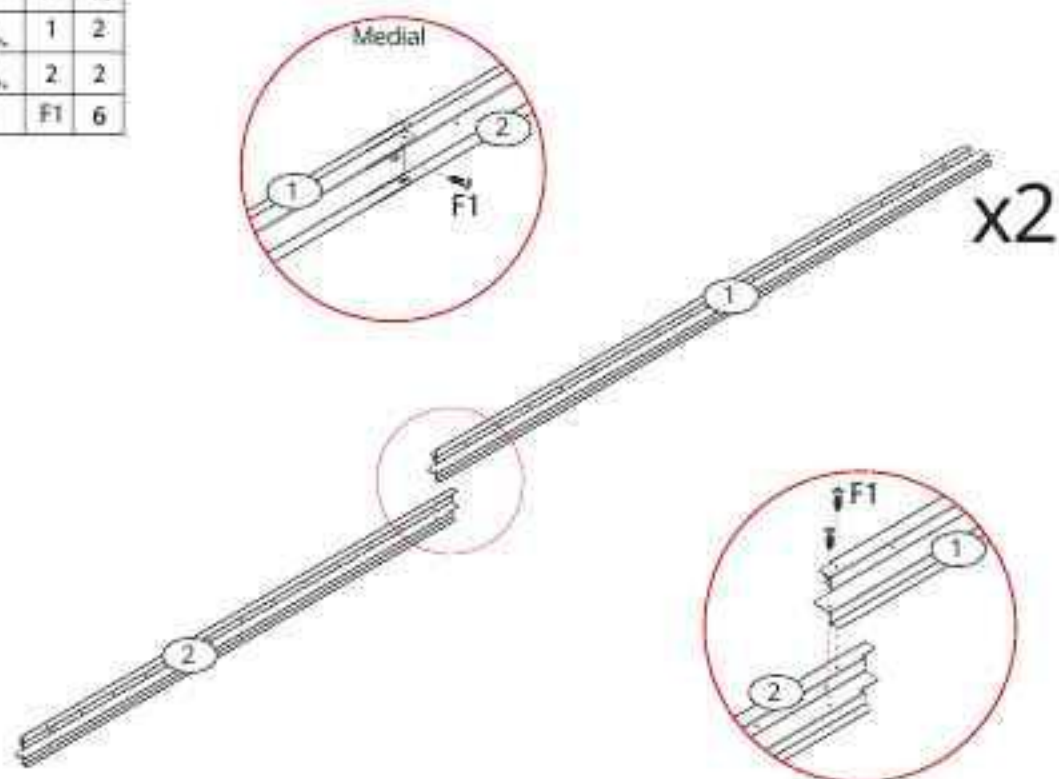

2

Parts	No	Qty
 4L	4L	2
 4R	4R	2
 F1	F1	6

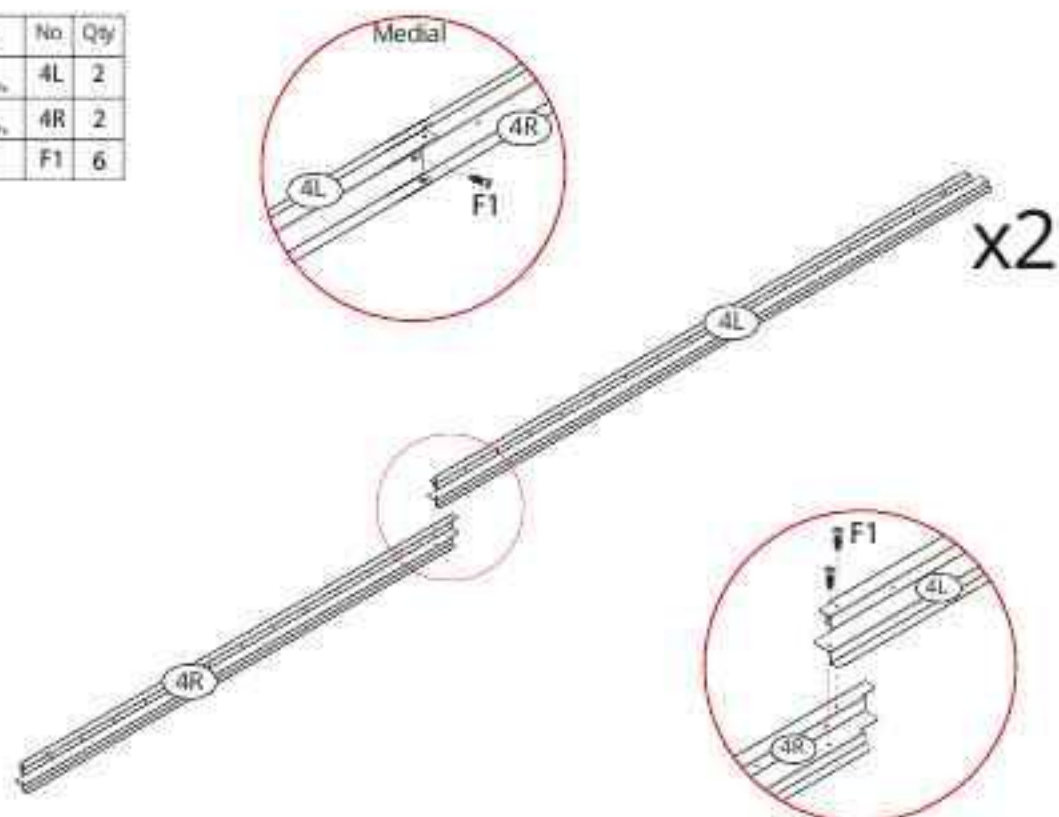

3

Parts	No	Qty
	3L	1
	3R	1
	F1	3

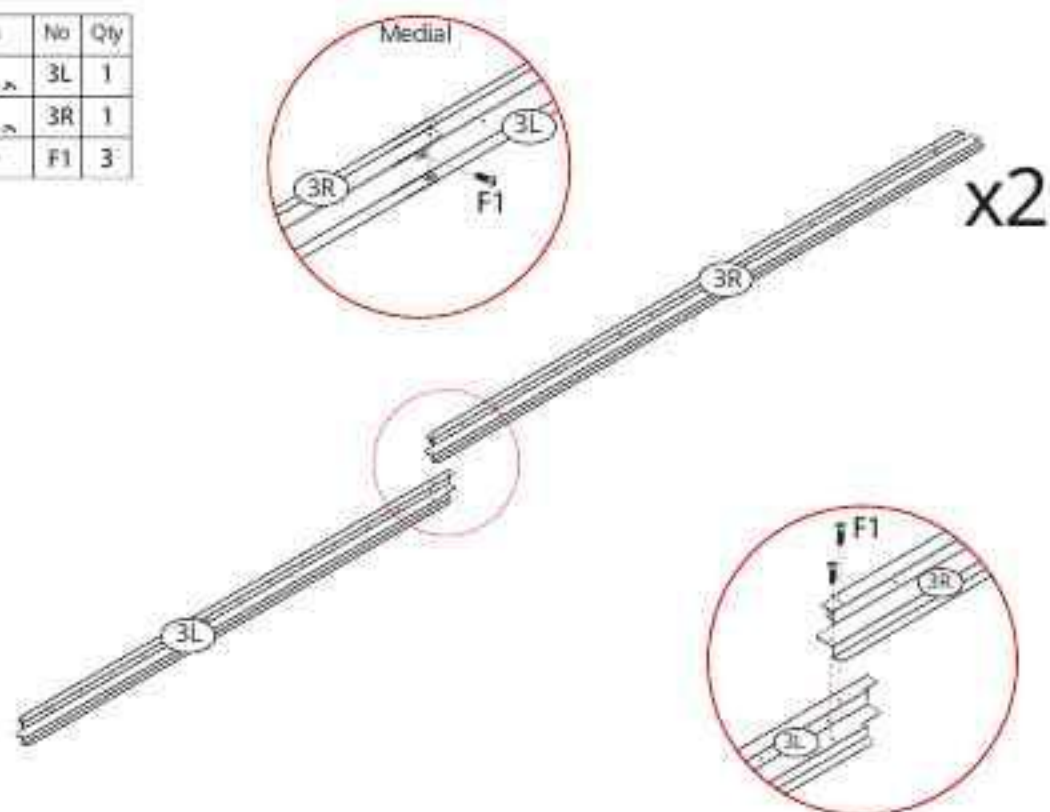

4

Parts	No	Qty
	F1	4

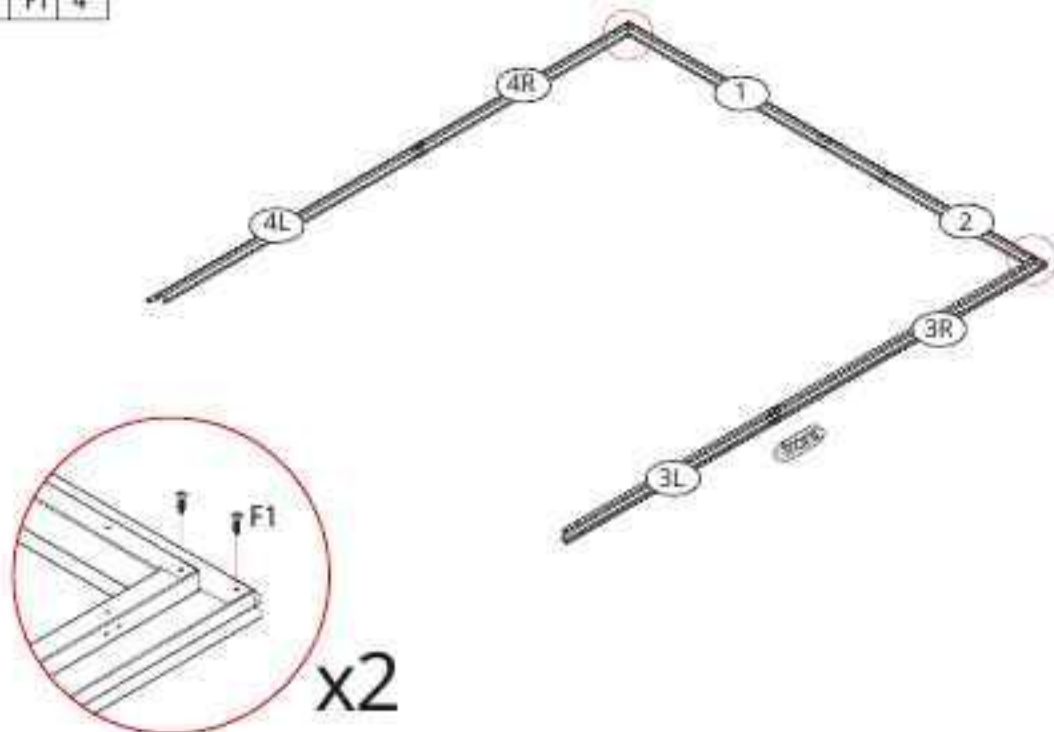

5

Parts	No	Qty
	F1	4

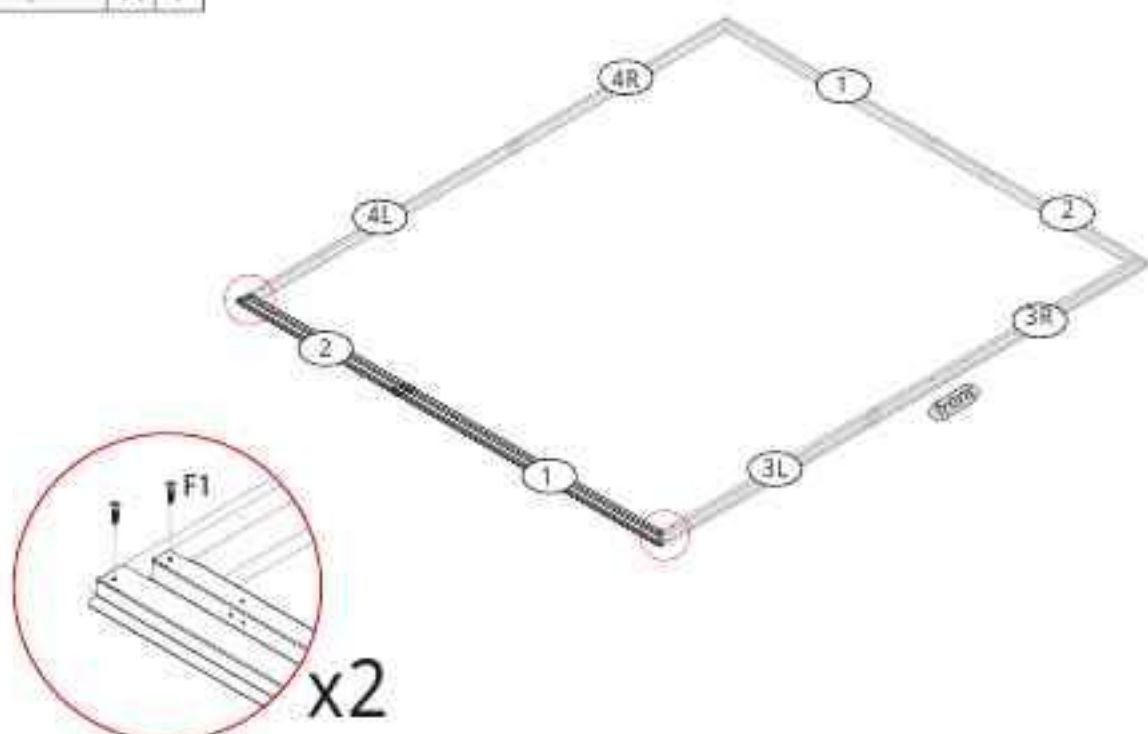

6

Parts	No	Qty
	4A	4
	F1	8

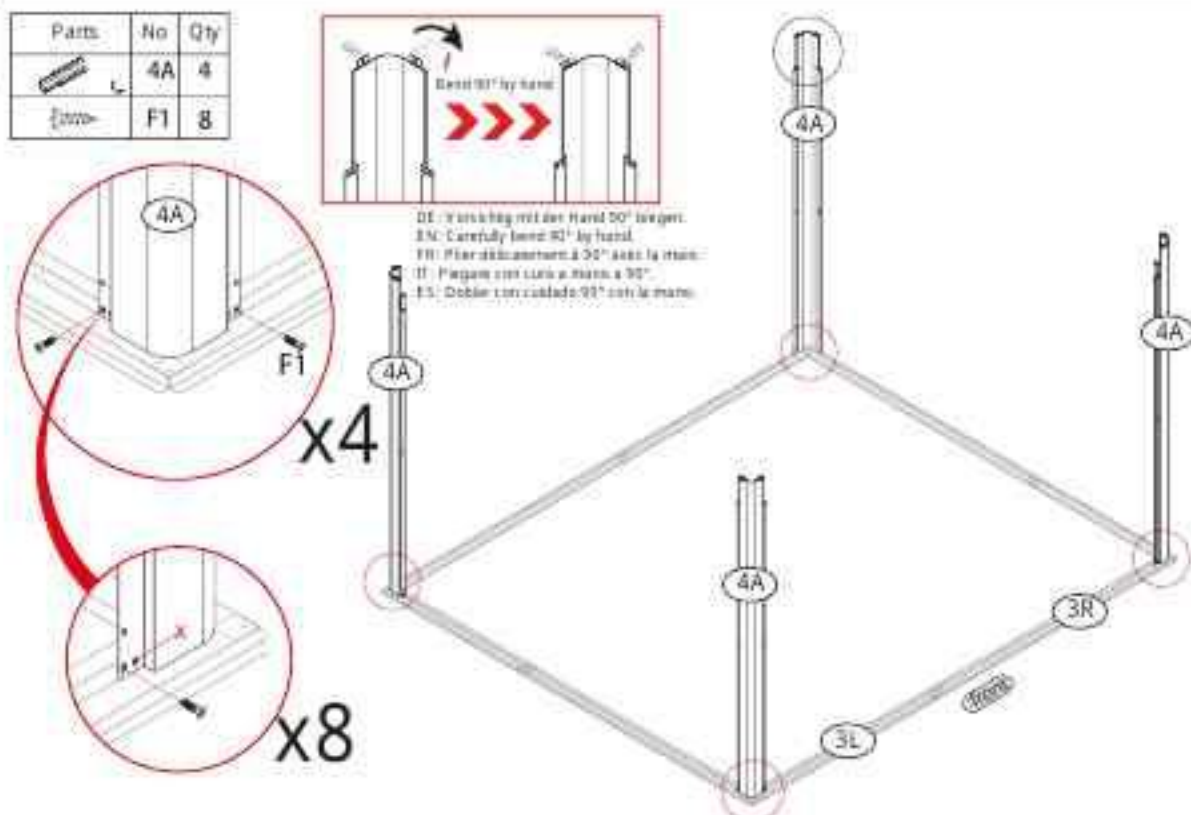

DE: Hinweis: Es werden nur die in den Abbildungen gezeigten Bauteile installiert.
 EN Note: Only the parts shown in the illustrations are installed.
 ES: Advertencia: solo los componentes mostrados en las ilustraciones serán instalados.
 IT: Nota: sono installati solo i componenti mostrati nelle illustrazioni.
 ES: Nota: Solo se instalan los partes que aparecen en las ilustraciones.

Parts	No	Qty
 10L	1	1
 10R	1	1
 GS	1	1
 F1	4	4

DE: Hinweis: Das kleine Loch befindet sich auf der Innenseite.

EN: Note: The small hole is on the inside.

FR: Remarque - le petit trou se trouve à l'intérieur.

IT: Nota: il foro piccolo si trova all'interno.

ES: Nota: El agujero pequeño está en el interior.

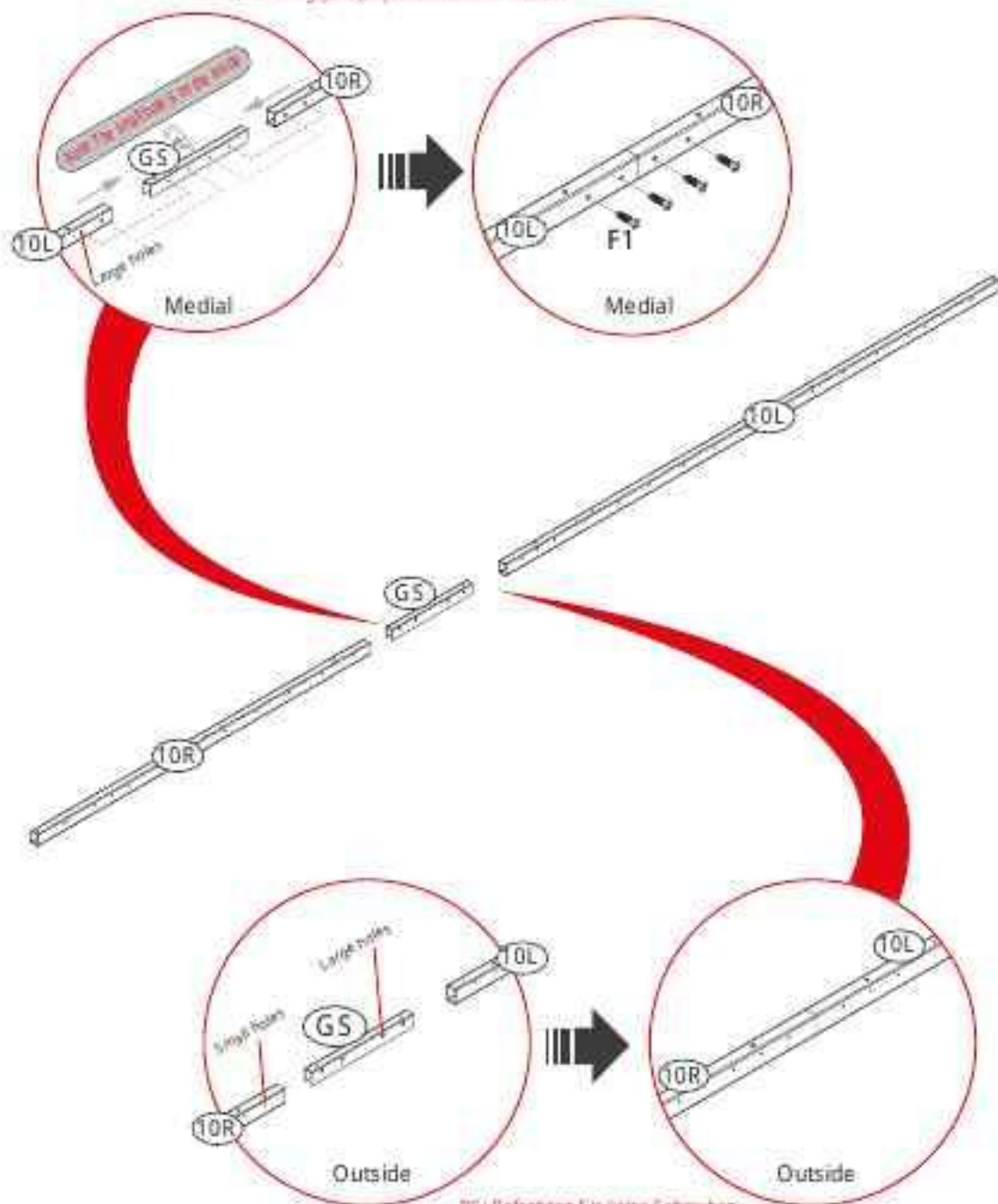

DE: Befestigen Sie keine Schrauben.

EN: Do not install any screws.

FR: Fixer No pas installer de vis.

IT: Non installare vis.

ES: No instale ningún tornillo.

Parts	No	Qty
 a	9	2
 a	11	2
 n	GS	2
 F1	F1	8

DE: Hinweis: Das kleine Loch befindet sich auf der Innenseite.

EN: Note: The small hole is on the inside.

FR: Remarque: Le petit trou se trouve à l'intérieur.

IT: Nota: Il foro piccolo si trova all'interno.

ES: Nota: El agujero pequeño está en el interior.

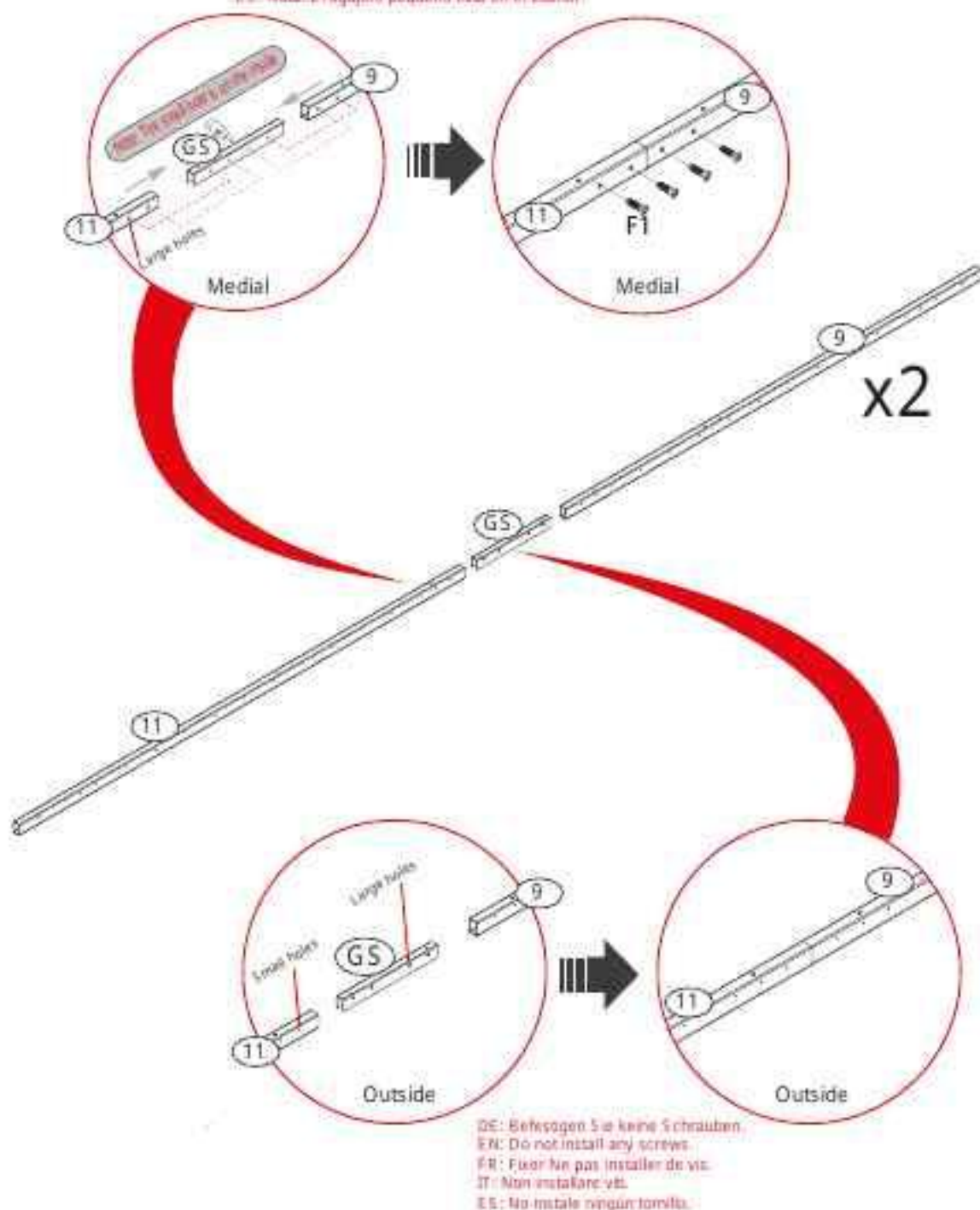

10

Parts	No	Qty
	F1	8

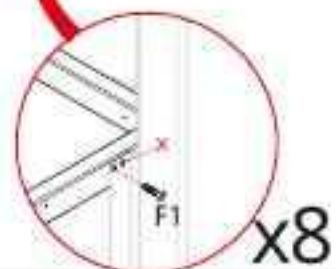
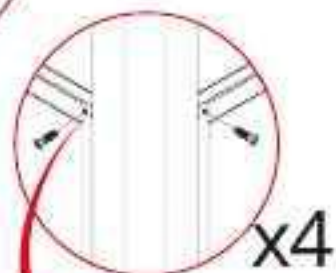
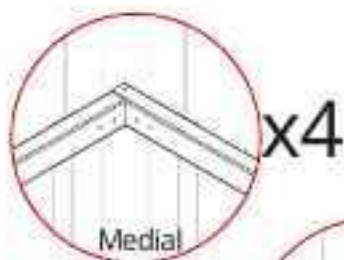
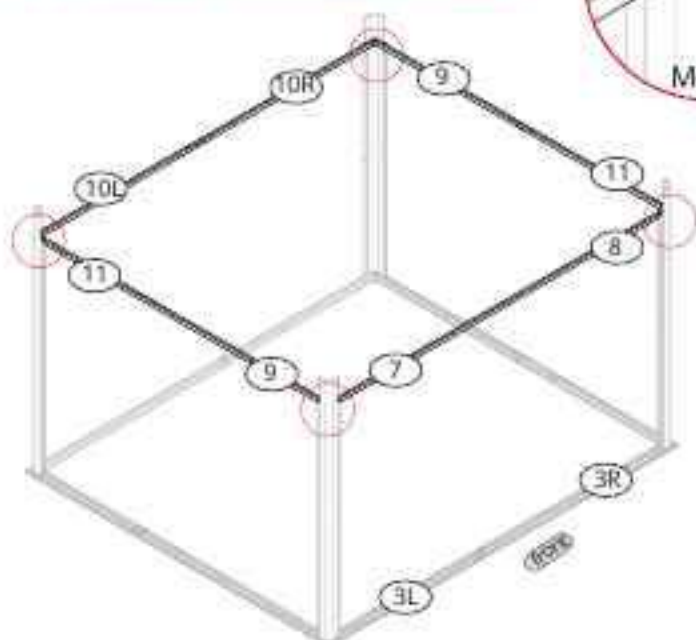

7, 8, 9, 11 One side of the condo faces outward

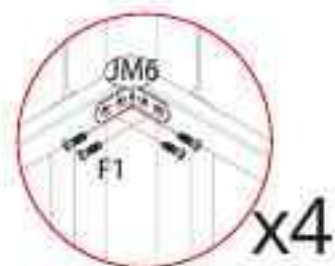
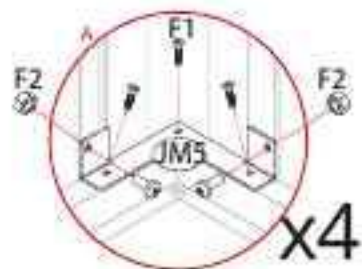
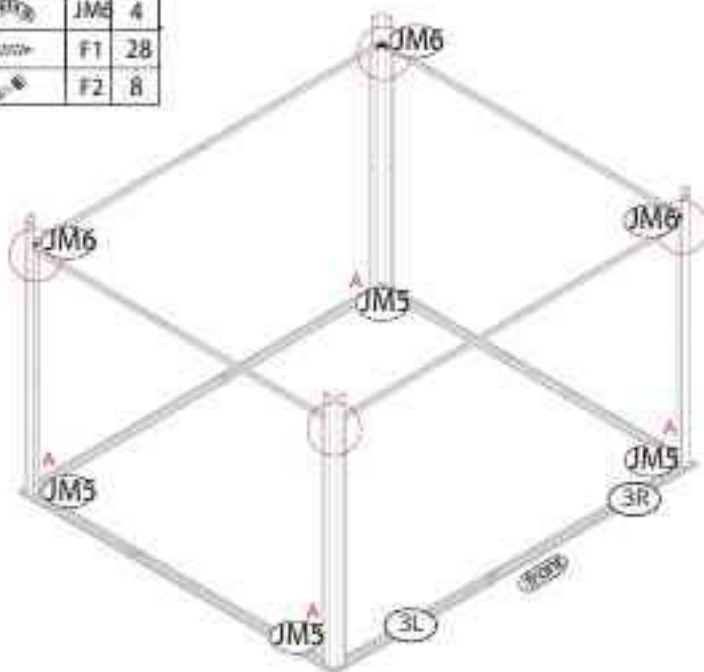

11

Parts	No	Qty
	JM5	4
	JM6	4
	F1	28
	F2	8



Parts	No	Qty
	9A	2
	11A	2
	F1	8

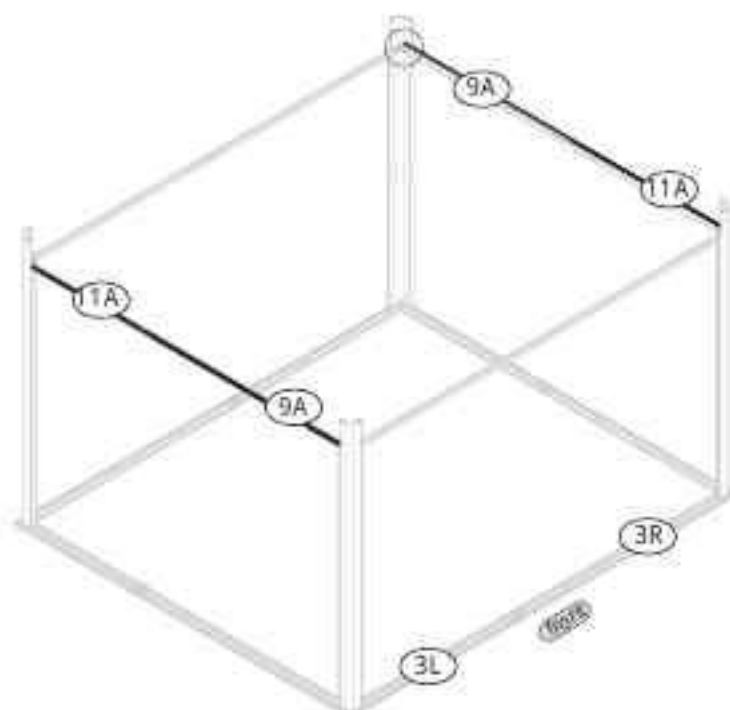
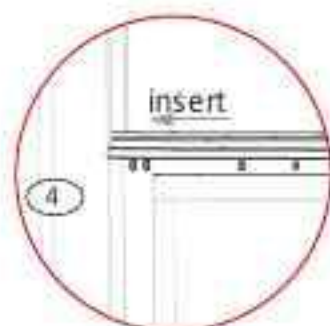
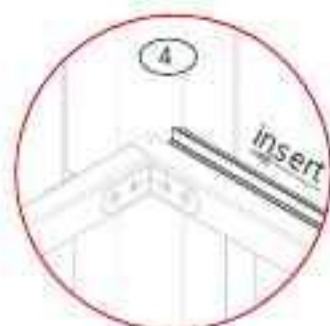

DE: Nur Rundloch-Befestigungsschrauben.
 EN: Only round hole mounting screws.
 FR: Vis de fixation à trou rond uniquement.
 IT: Solo vite di fissaggio a foro tondo.
 ES: Sólo tornillos de fijación de agujero redondo.

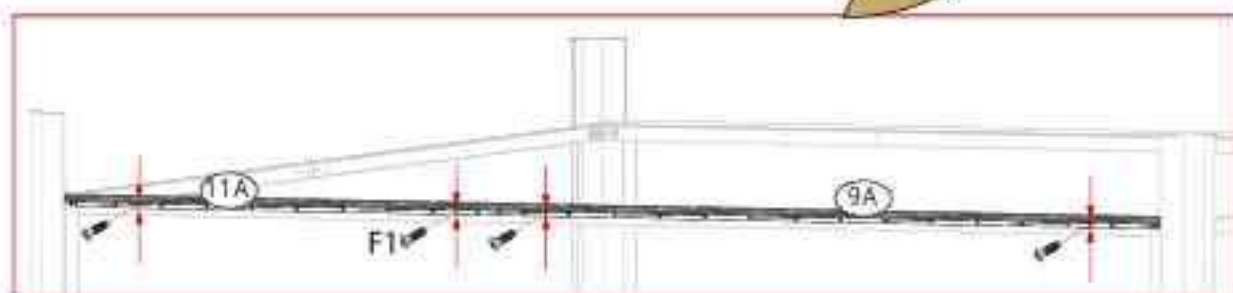
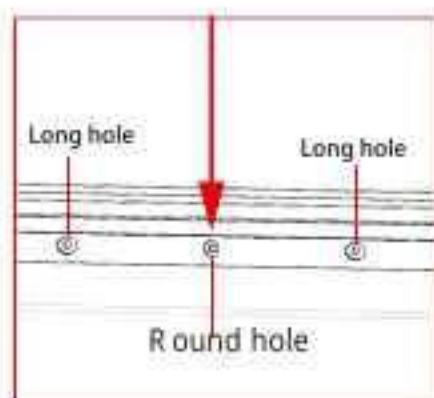

x2

Parts	No	Qty
	7A	1
	8A	1
	10LA	1
	10RA	1
	F1	8

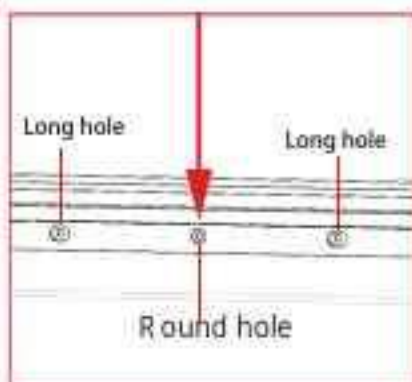
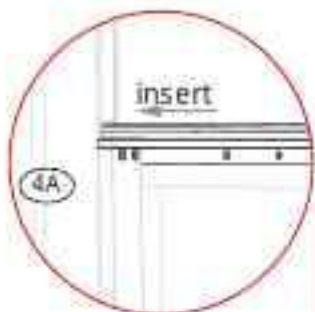
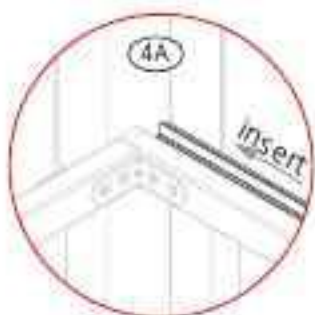
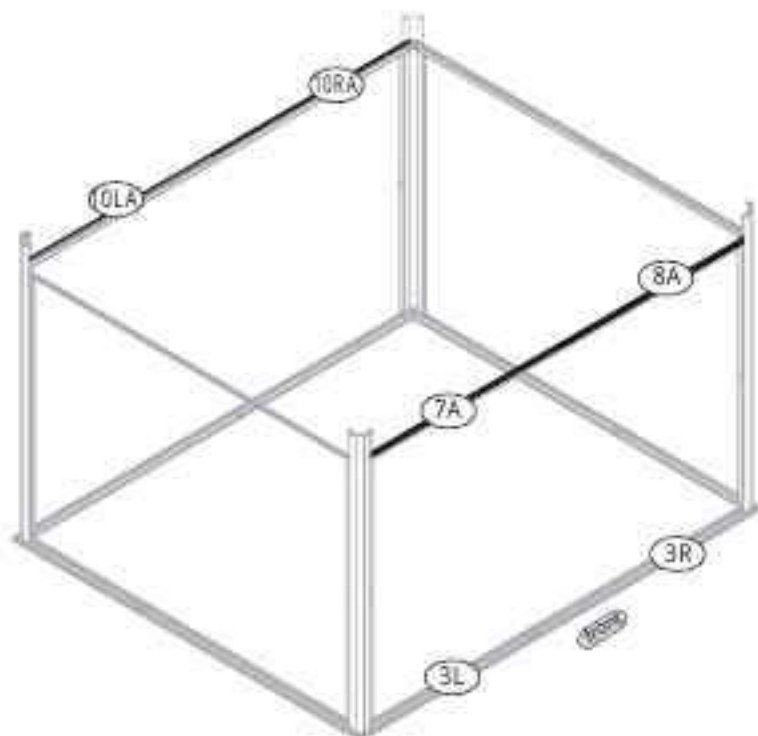

DE: Nur Rundloch-Befestigungsschrauben.
 EN: Only round hole mounting screws.
 FR: Vis de fixation à trou rond uniquement.
 IT: Solo vit di fissaggio a foro tondo.
 ES: Sólo tornillos de fijación de agujero redondo.

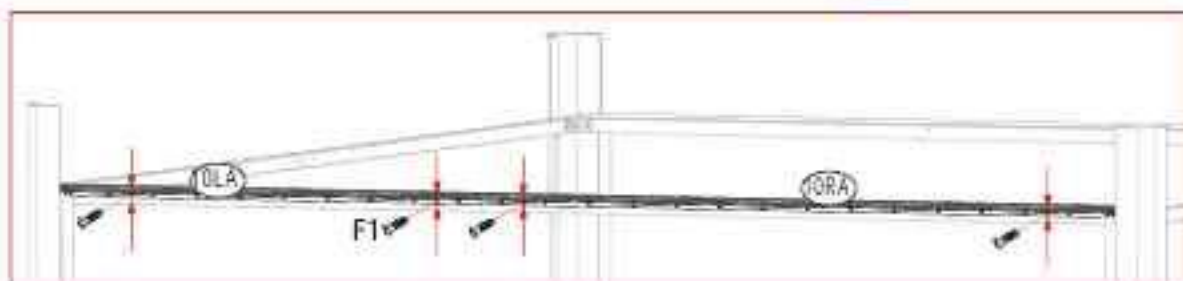

x2

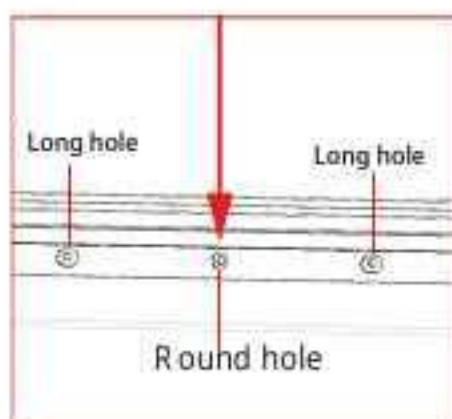
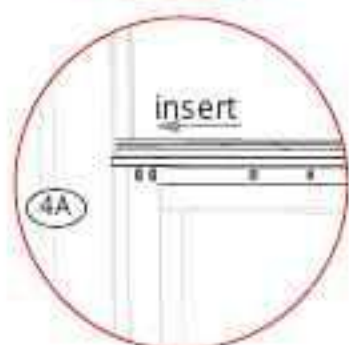
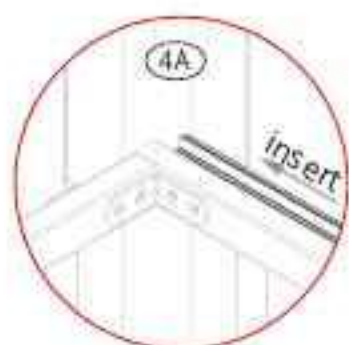

DE: Nur Rundloch-Befestigungsschrauben.
 EN: Only round hole mounting screws.
 FR: Vis de fixation à trou rond uniquement.
 IT: Solo viti di fissaggio a foro tondo.
 ES: Solo tornillos de fijación de agujero redondo.

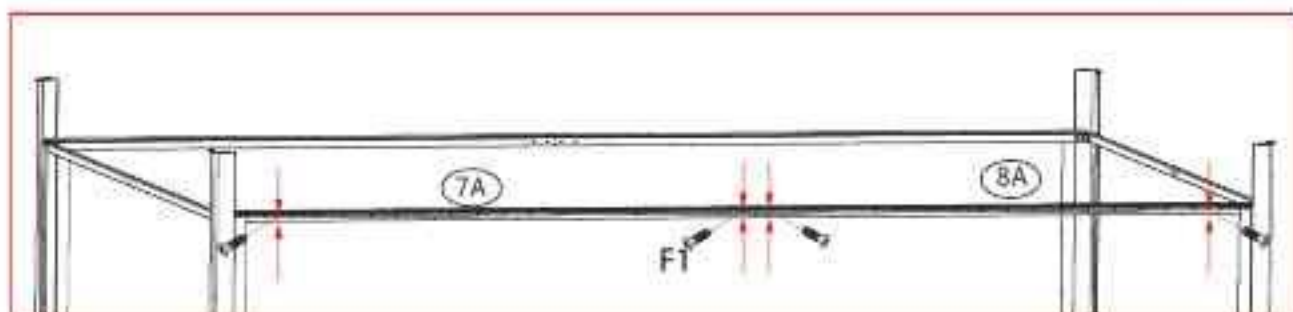



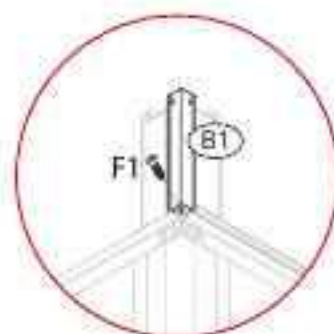
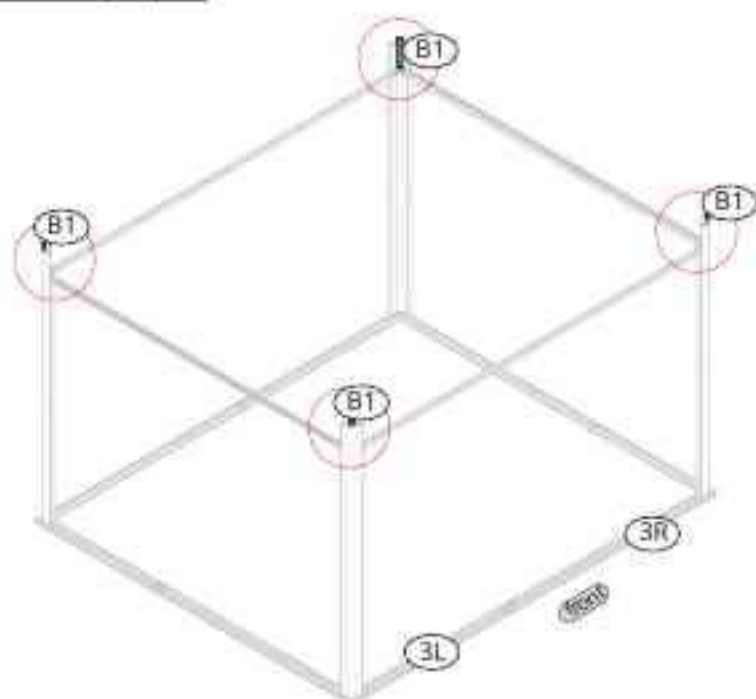

15

Parts	No	Qty
	B1	4
	F1	4



16

Parts	No	Qty
	P2A	4
	P3A	4
	F1	50
	S2	50

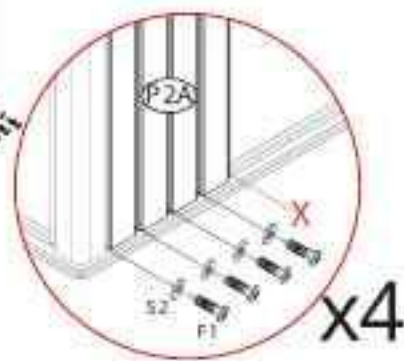
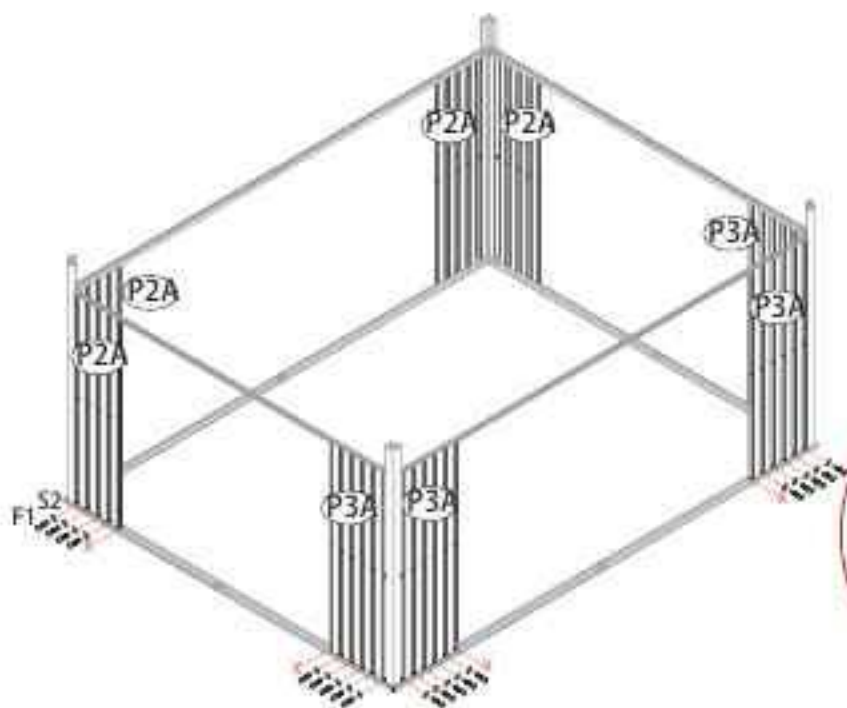

17

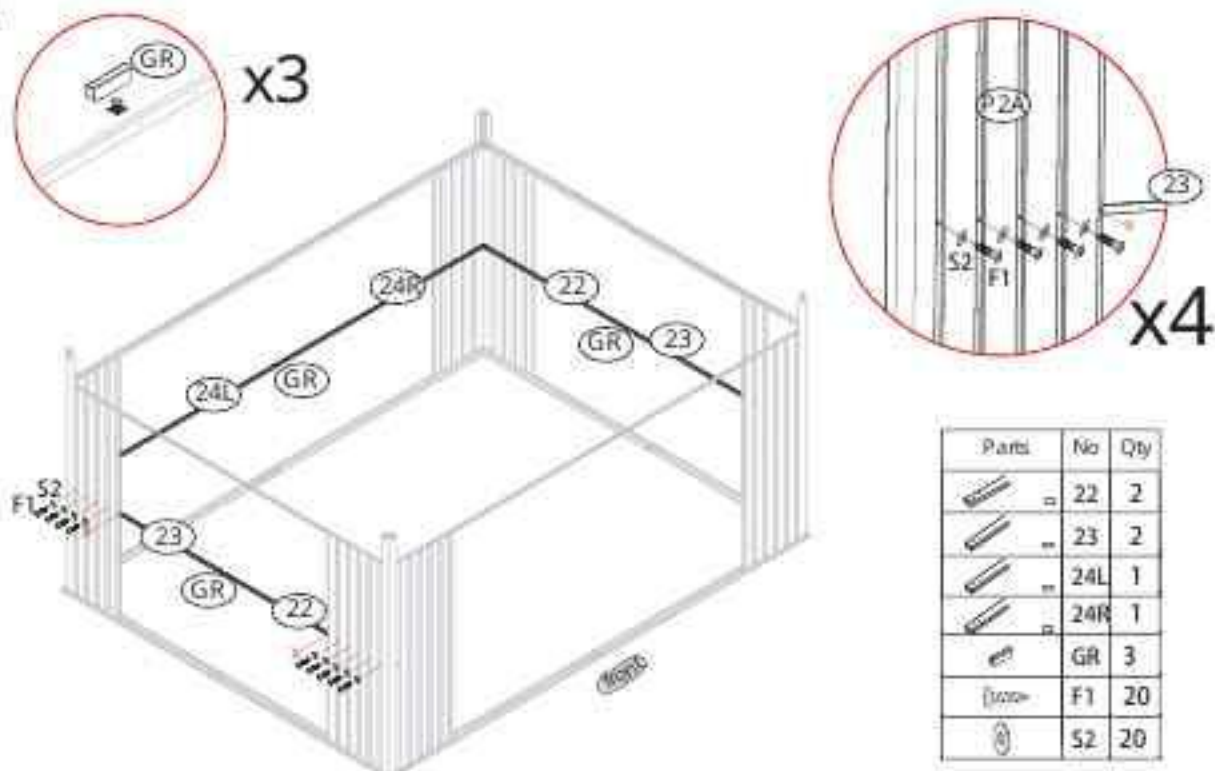

18

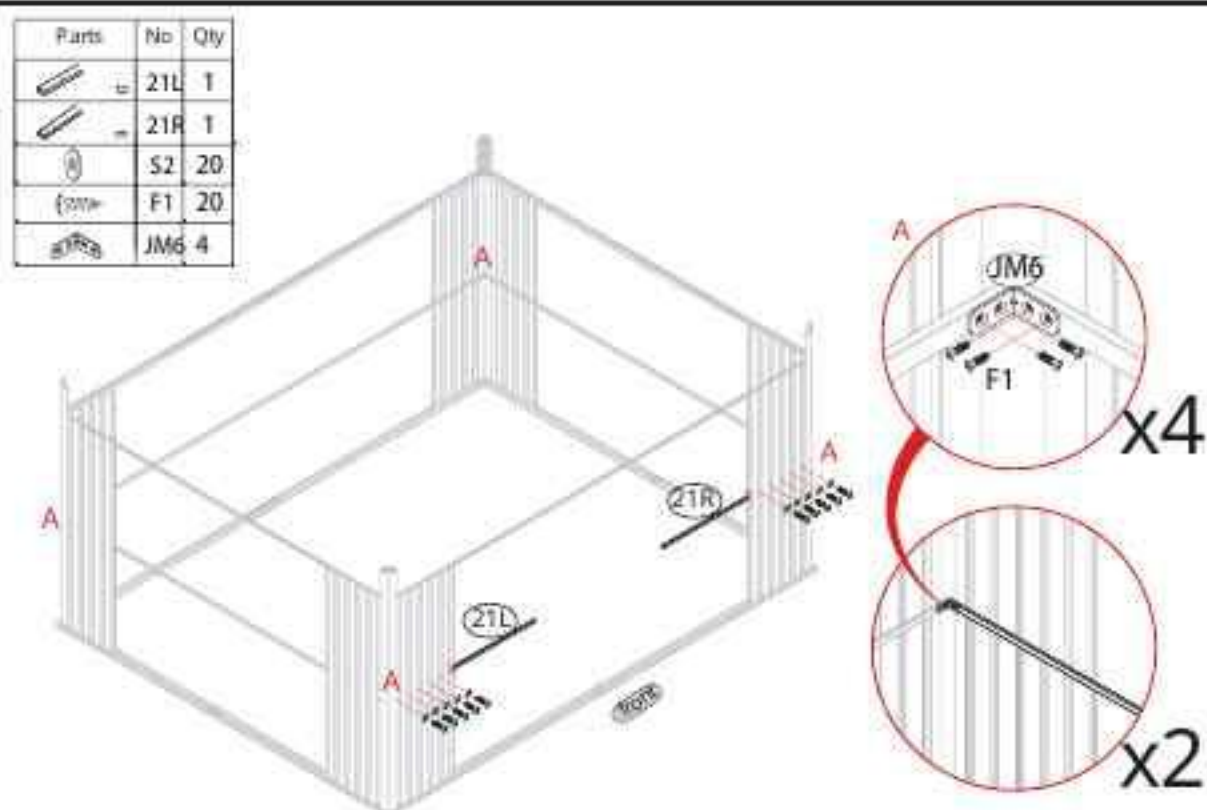

19

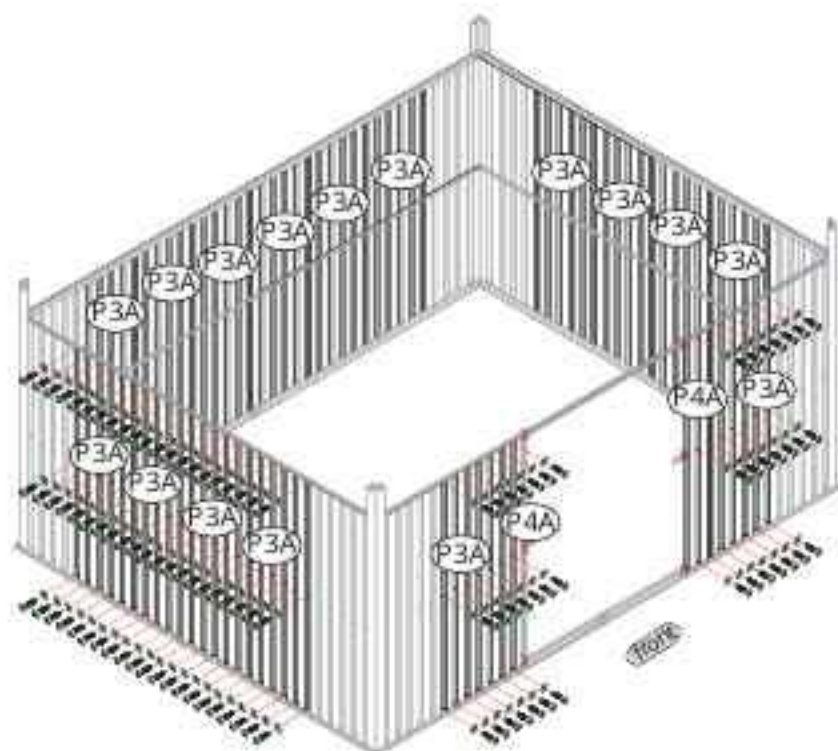
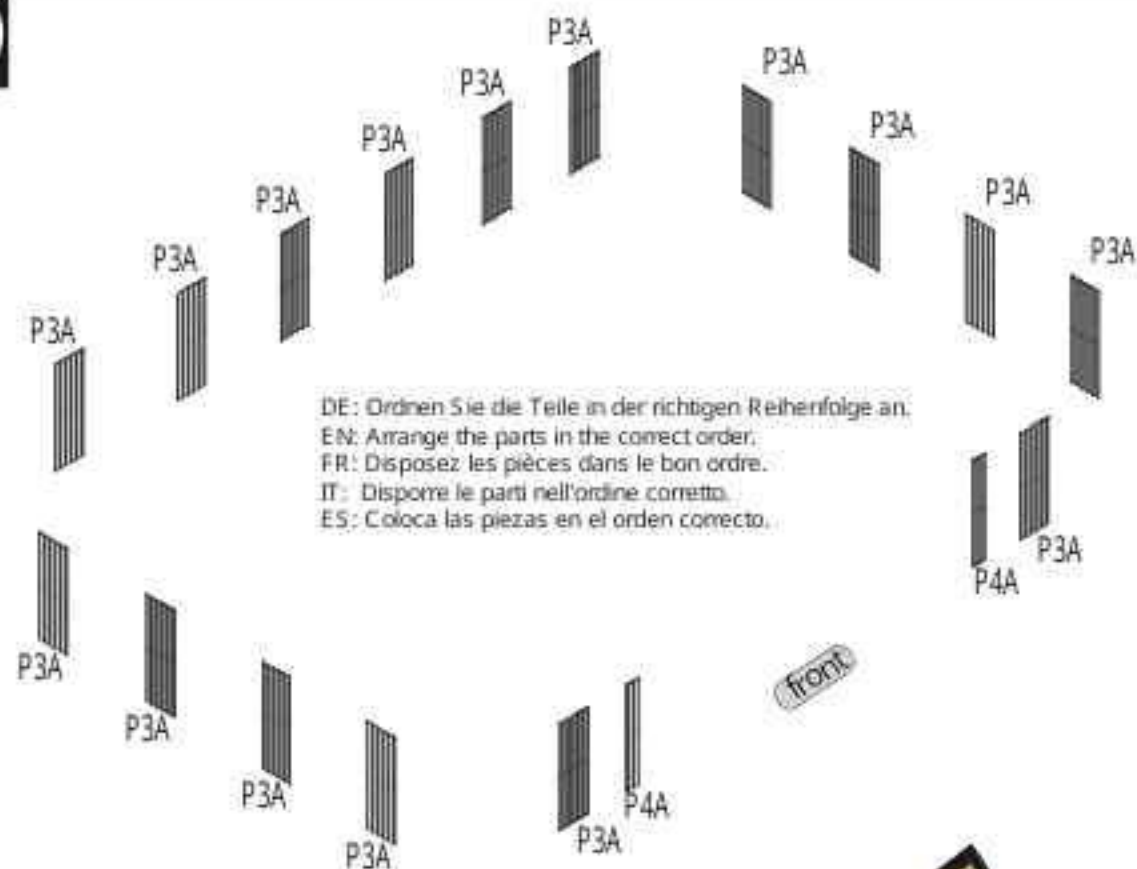

Parts	No	Qty
 P4A	2	
 P3A	16	
 F1	100+	
 S2	100+	

20

Parts	No	Qty
	12	4

This step hides all the boards
for a clearer view of the installation behind

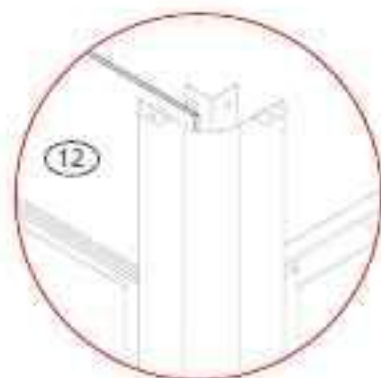
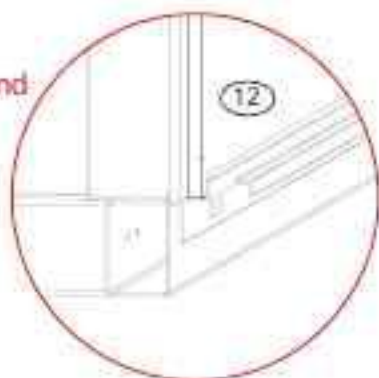
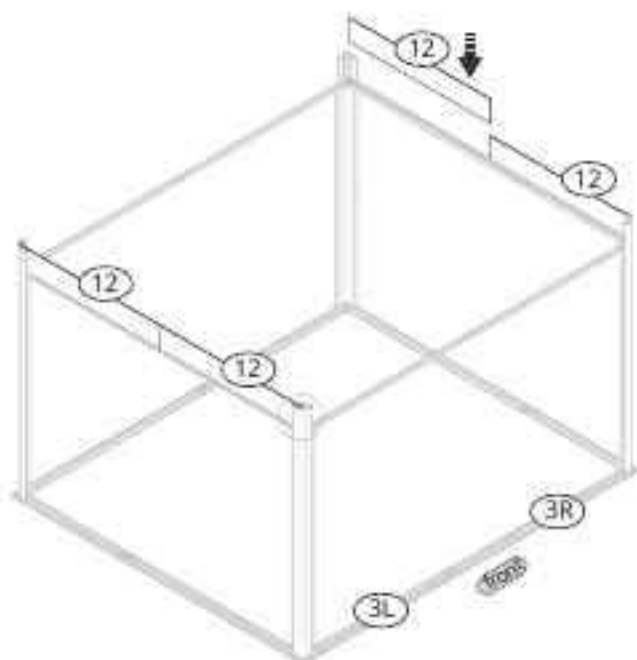

21

Parts	No	Qty
	10	4

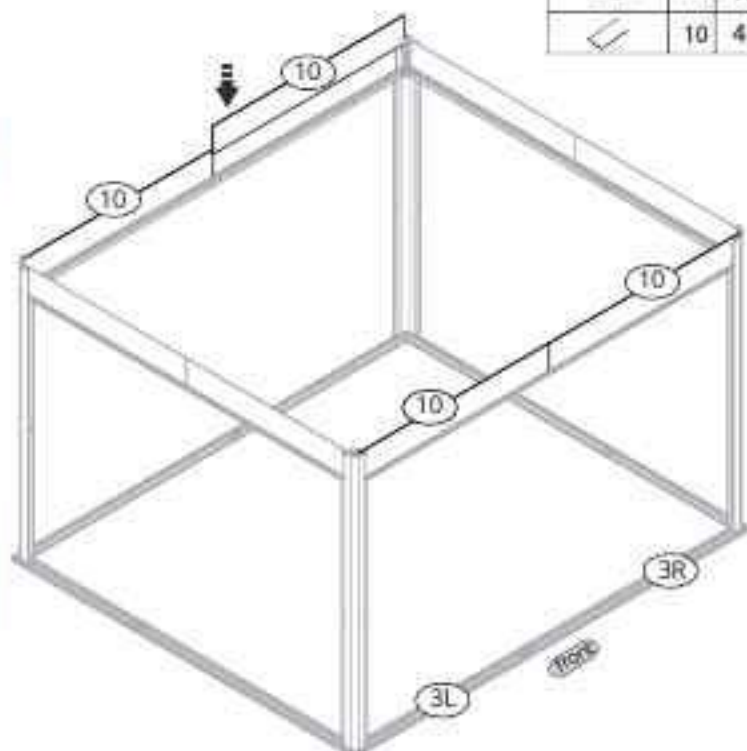
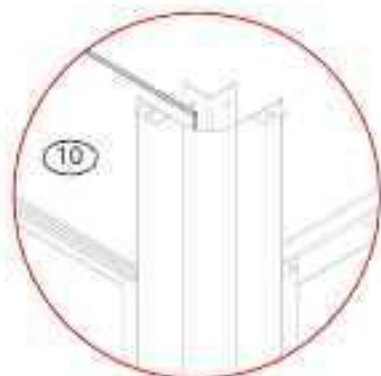
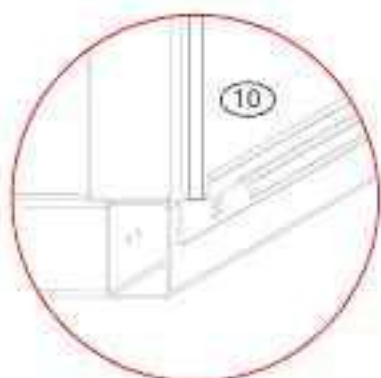

22

Parts	No	Qty
	15LA	1
	15RA	1
	16LA	1
	16RA	1
	17LA	2
	17RA	2

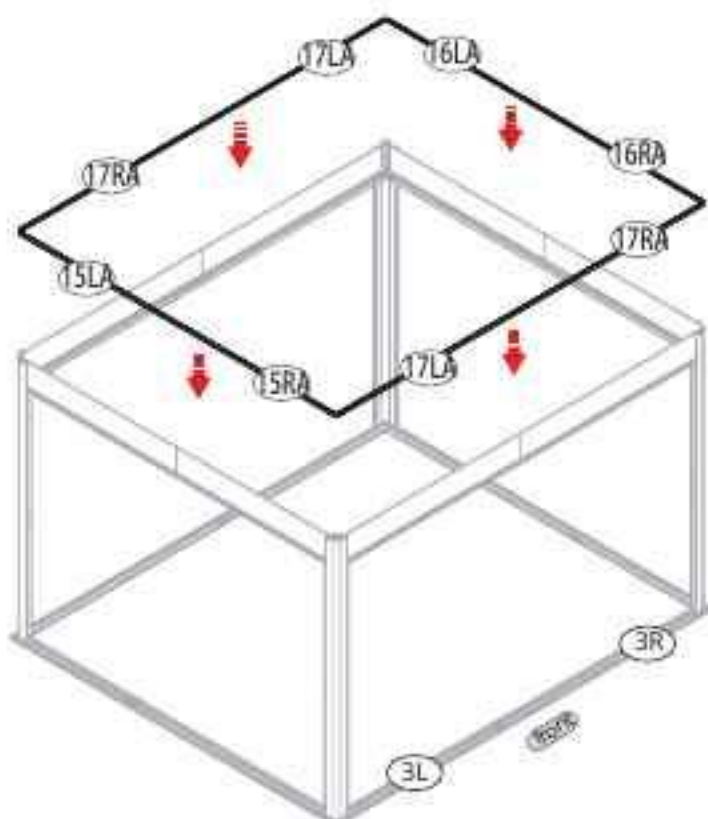



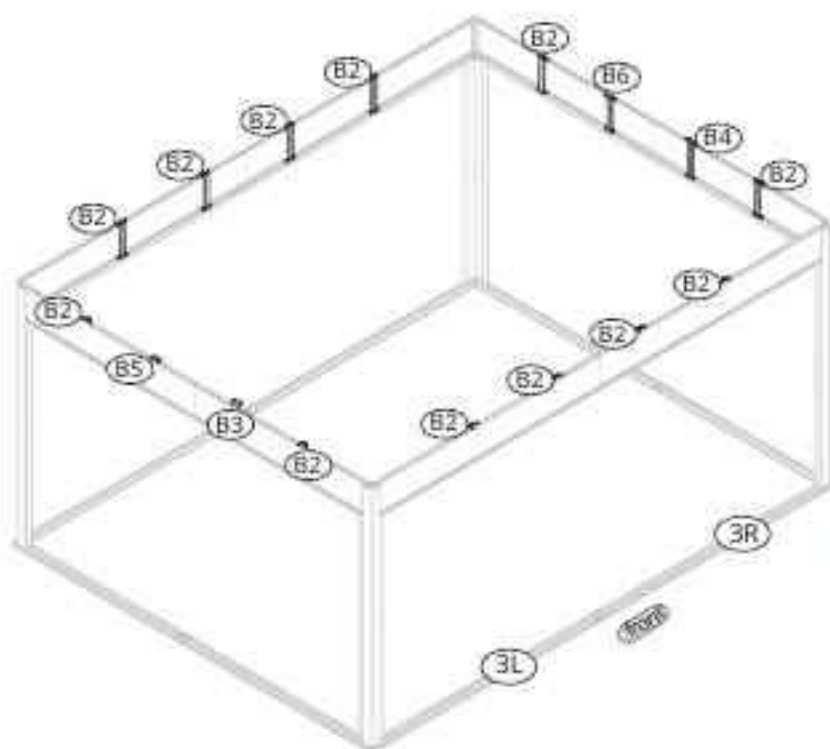

23

This step hides all the boards for a clearer view of the installation behind

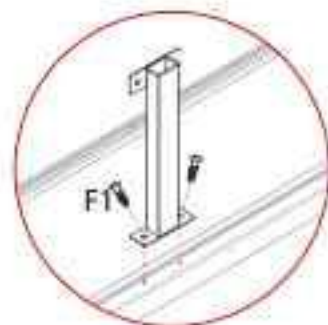

Parts	No	Qty
	B2	12
	B3	1
	B4	1
	B5	1
	B6	1
	F1	32



Parts	No	Qty
	25L	1
	25R	1
	F1	10
	S2	10

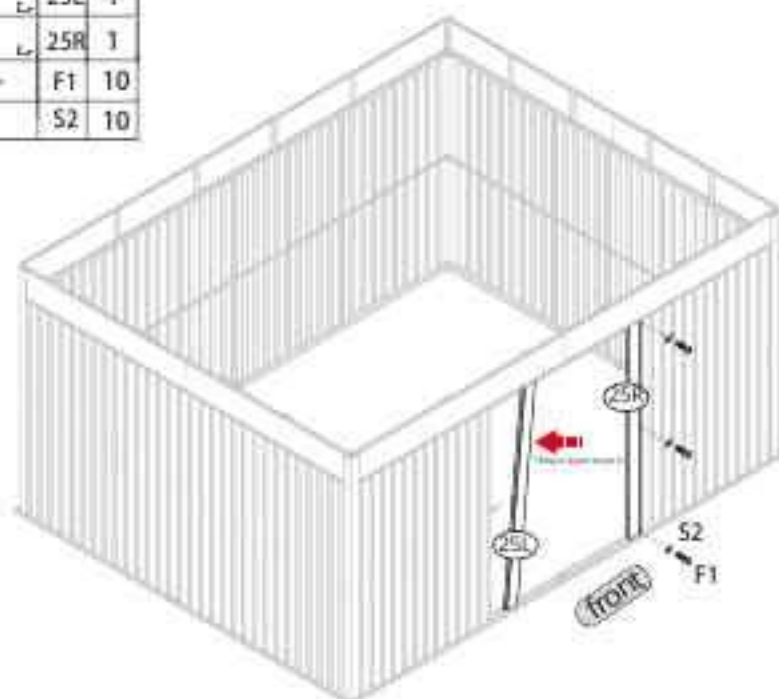

Parts	No	Qty
	13	2
	13A	2
	14	2
	15	2
	F5	8
		8

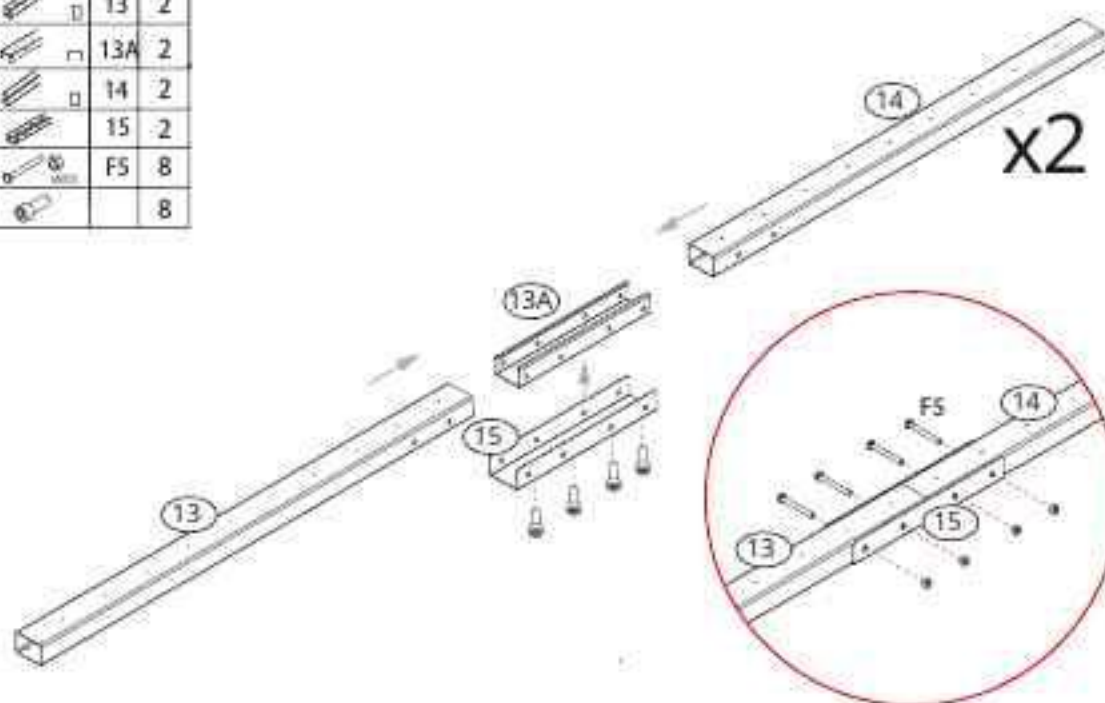

26

Parts	No	Qty
	F1	8

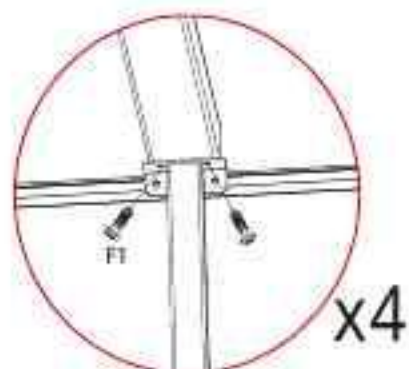
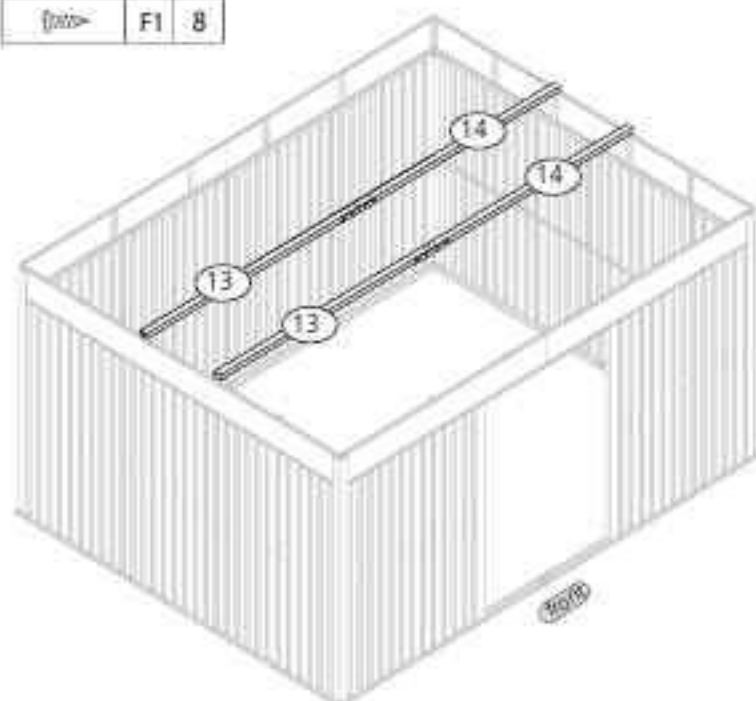

27

Parts	No	Qty
	F6	12
	F1	2
	S2	2

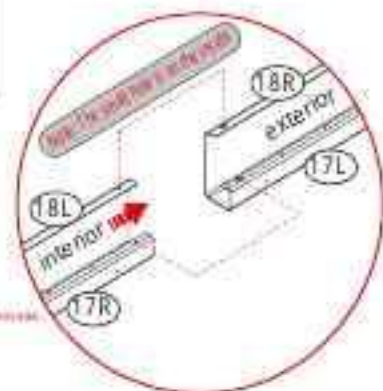
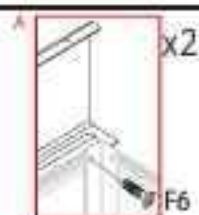
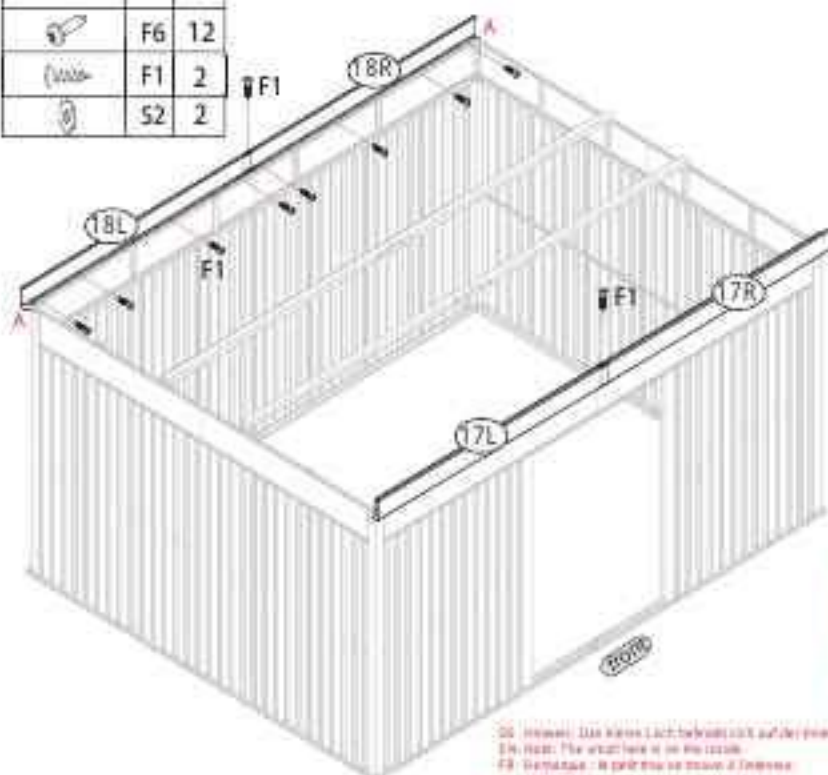



26. Inserire due barre laterali nella parte superiore.
 27. Montare il telaio superiore.
 28. Montare il telaio superiore.
 29. Montare il telaio superiore.
 30. Montare il telaio superiore.
 31. Montare il telaio superiore.

28

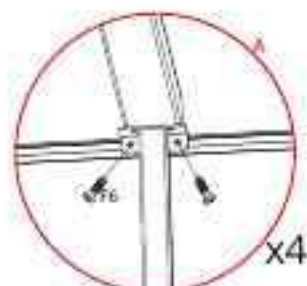
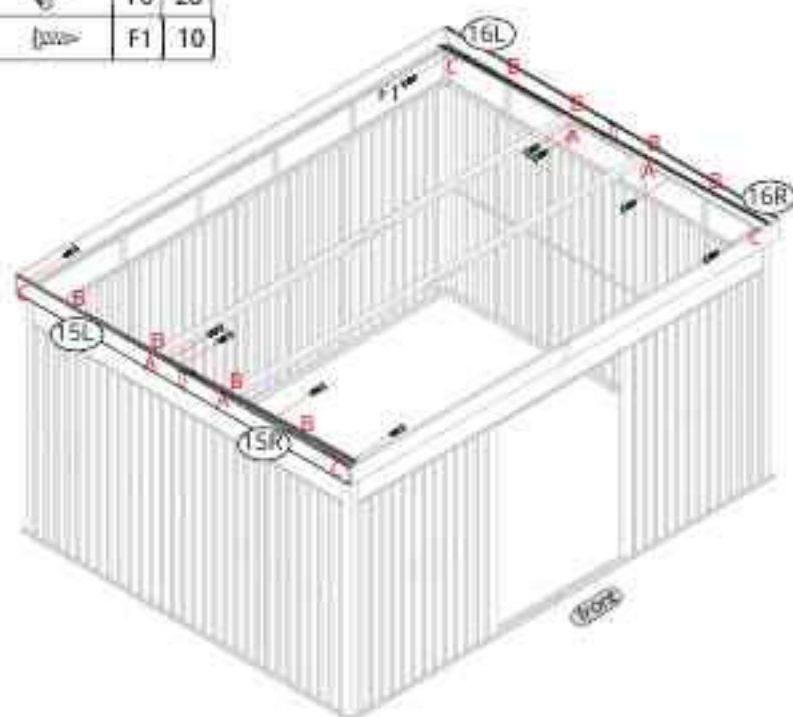
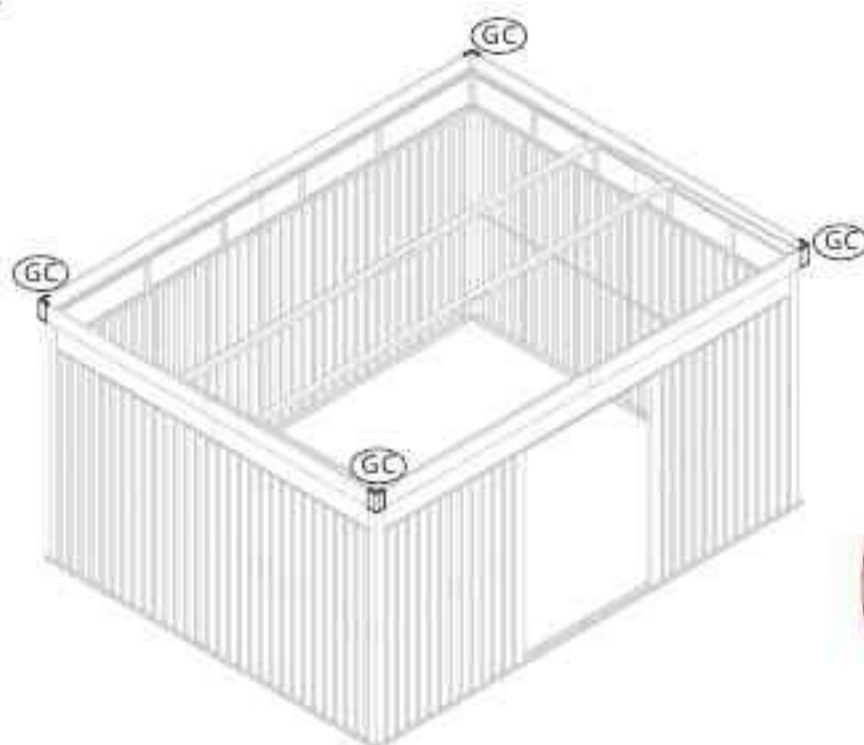
Parts	No	Qty
	F6	28
	F1	10

**29**

Parts	No	Qty
	GC	4
	F1	16

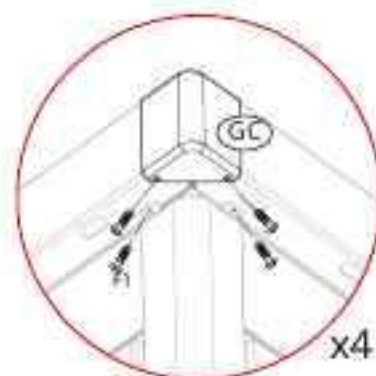

30

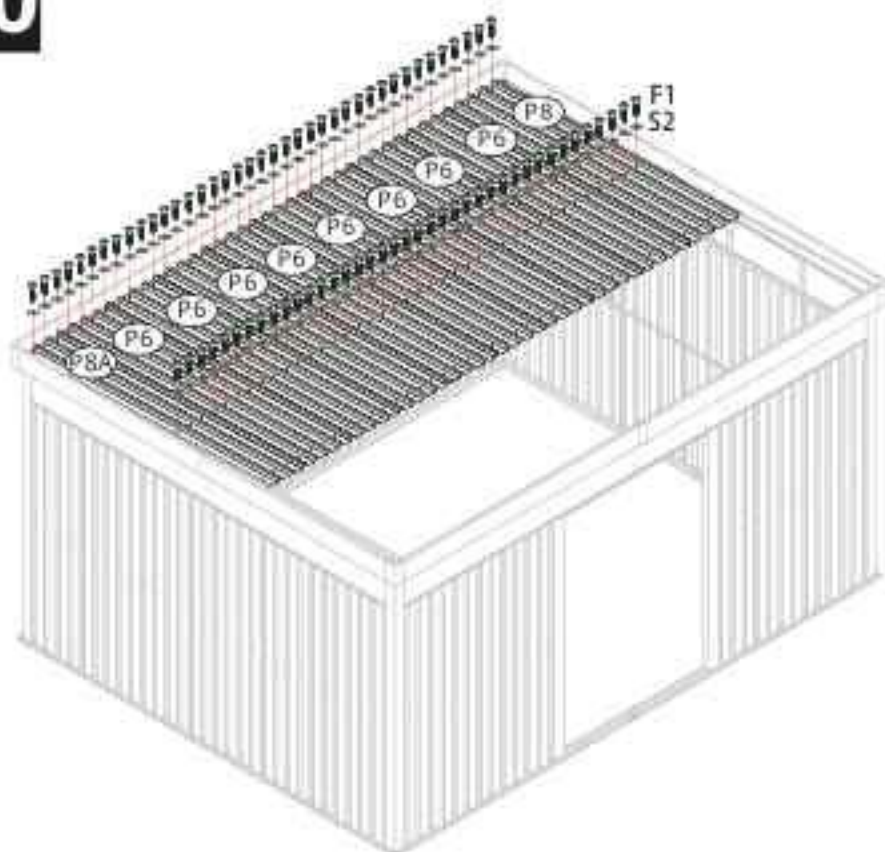

Parts	No	Qty
	P6	8
	P8	1
	P8A	1
	F1	78
	S2	78

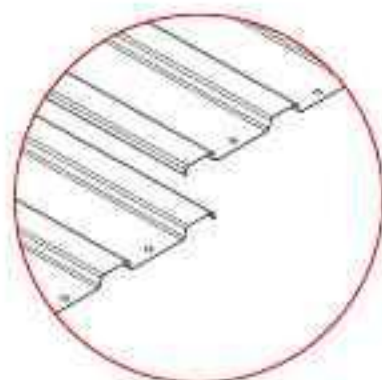

31

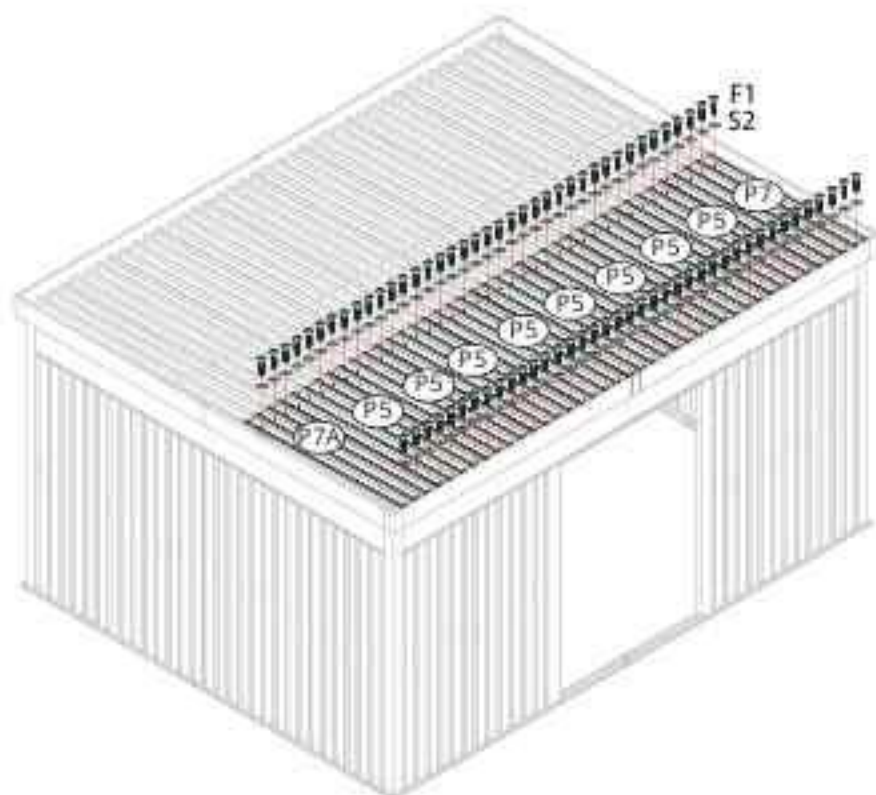

Parts	No	Qty
	P5	8
	P7	1
	P7A	1
	F1	78
	S2	78

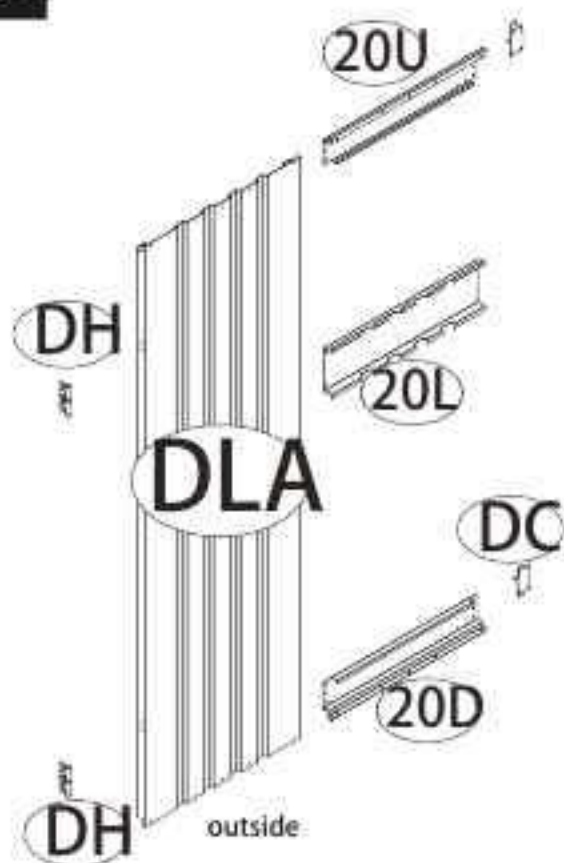

DE: Bitte ordnen Sie die Teile zuerst richtig an, bevor Sie anfangen.
 EN: Please arrange the parts correctly before you start.
 FR: Veuillez d'abord disposer les pièces correctement avant de commencer.
 IT: Prima di iniziare, disporre correttamente le parti.
 ES: Coloque las piezas correctamente antes de empezar.

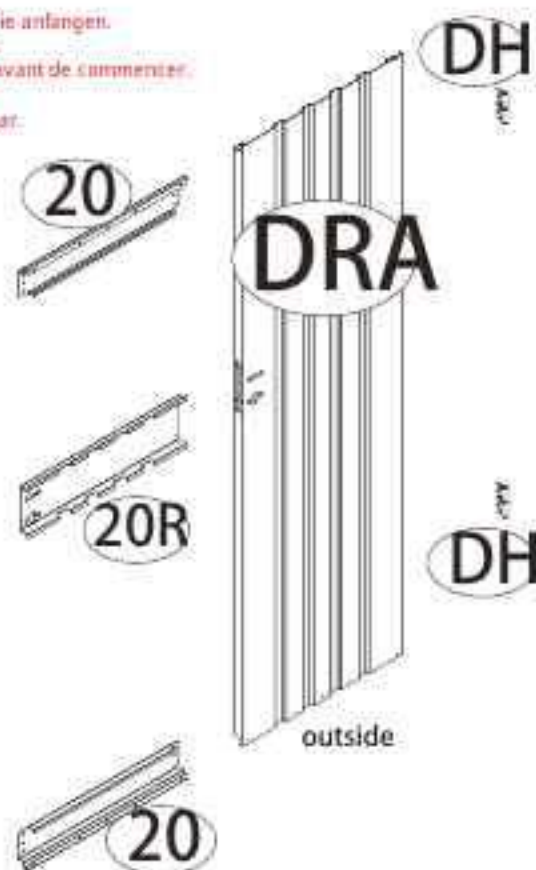

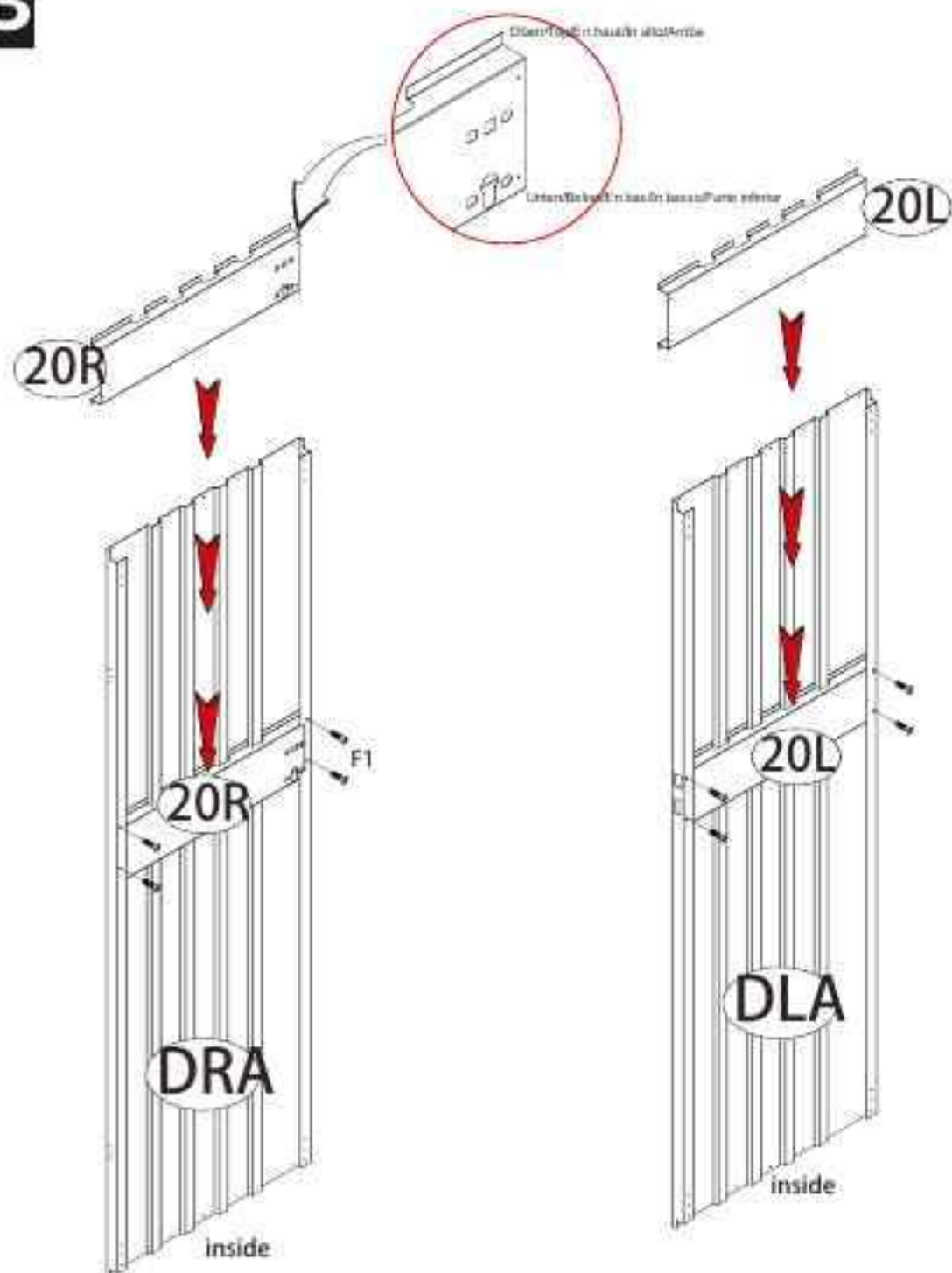

Parts	No	Qty
Üstten	F1	4

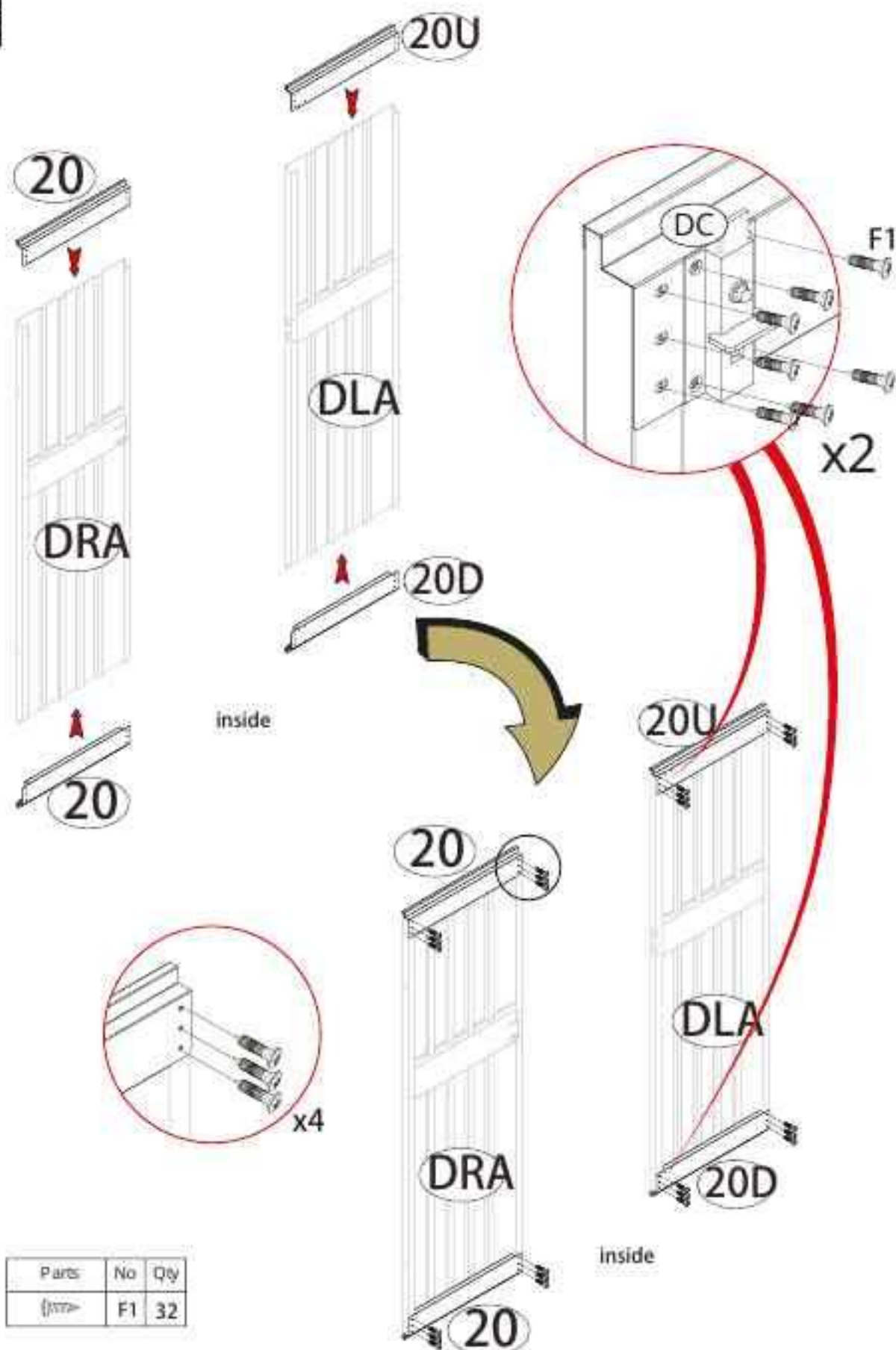

Parts	No	Qty
	F1	20
	F3	12
	S2	20

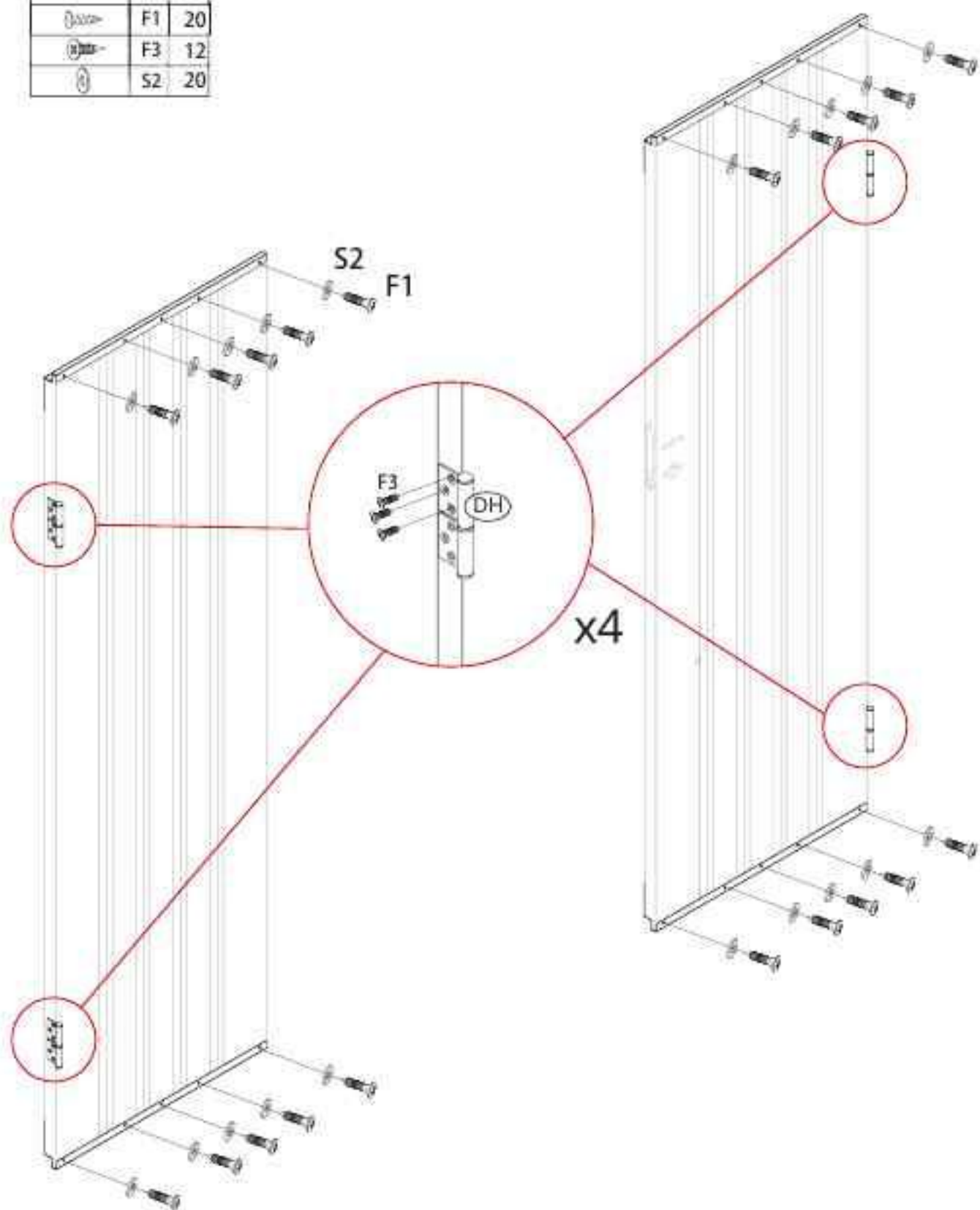

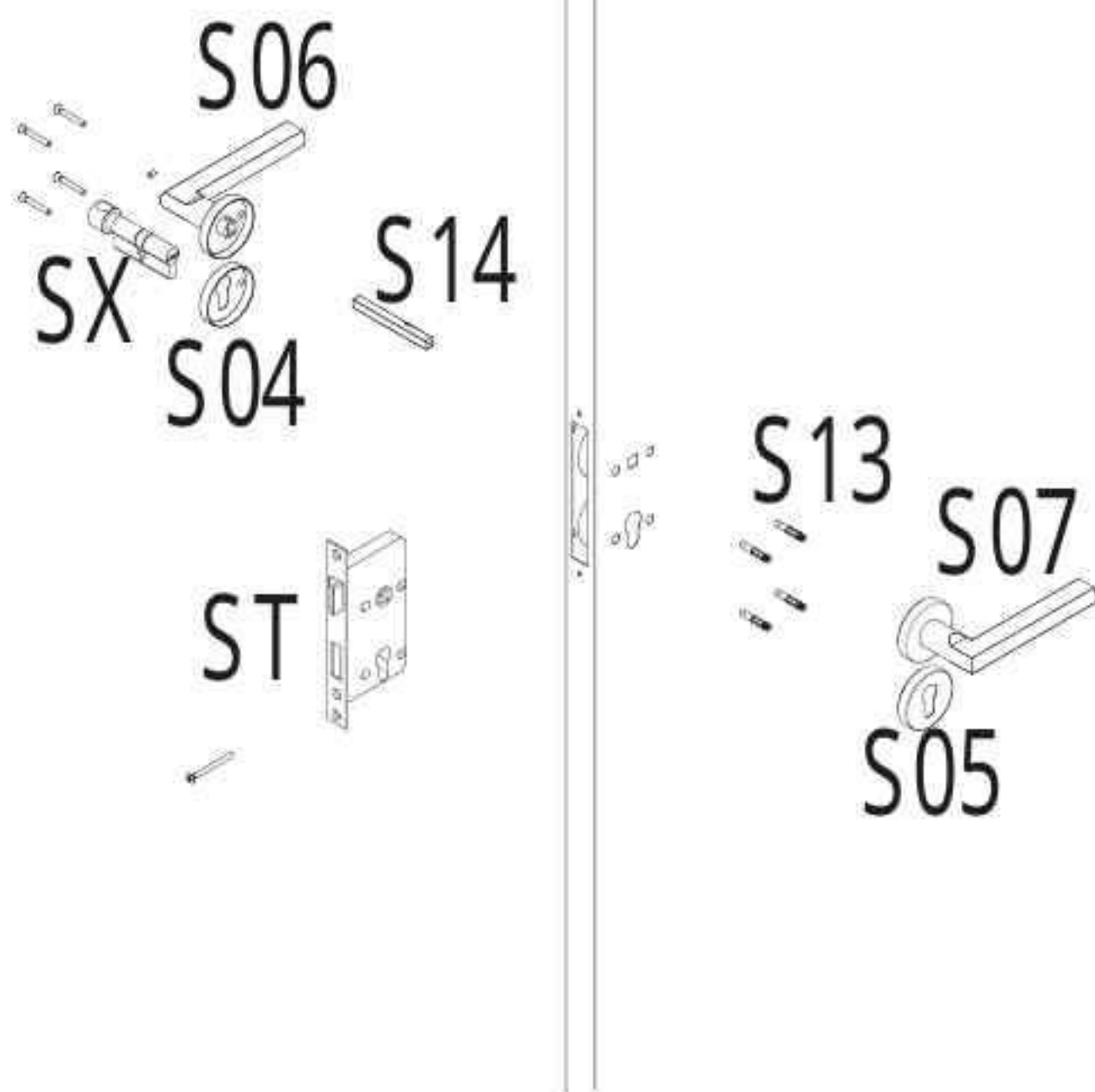

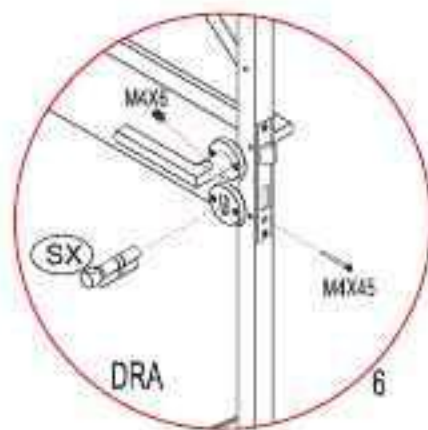
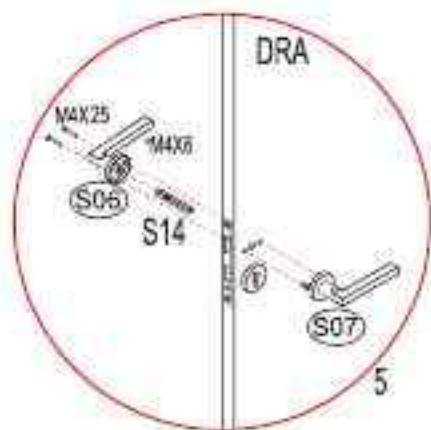
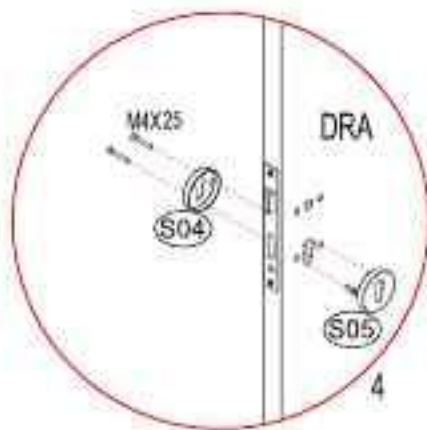
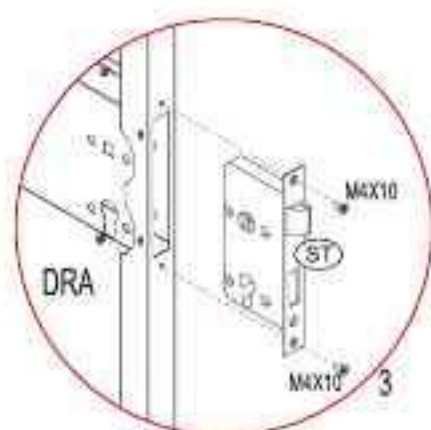
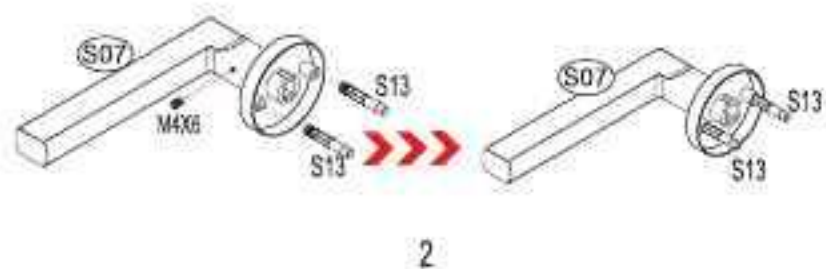
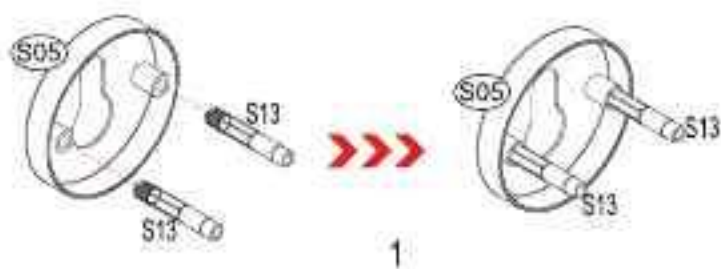

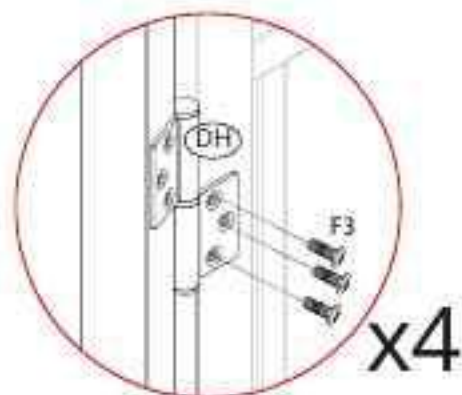

Parts	No	Qty
	F3	12

Parts	No	Qty
	F6	12

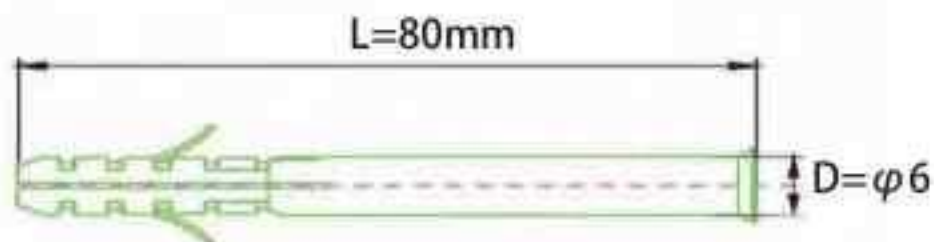
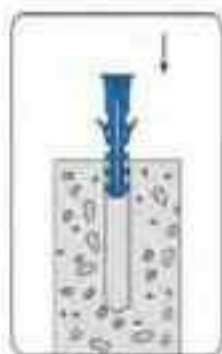
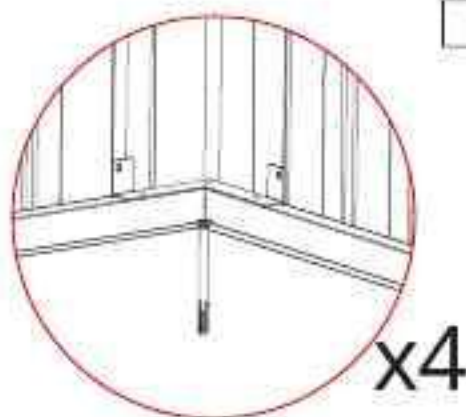

- DE: Technische Änderungen, Druckfehler und Irrtümer vorbehalten.
- EN: Technical changes, misprints and errors excepted.
- FR: Sous réserve de modifications techniques, de fautes d'impression et d'erreurs.
- IT: Con riserva di modifiche tecniche, refusi ed errori.
- ES: Salvo cambios técnicos, erratas y errores.